

## INDOOR

An intelligent range of lighting solutions for indoor use. Simple, trendy yet utility based, these luminaires are designed on a minimalistic perspective and come in classic cone, cylinder and sphere shapes. Unobtrusive and restrained, they blend in subtly with the decor to create an inviting mood.



Chokola, Gurgaon



# RECESSED DOWNLIGHTS

Combining style and functionality, these downlights are created for optimum light throw and efficiency. Available in a range of diffused and spot glows, there is one to suit each of your need. They are easy to install and can be customised with finish, optics and LED color options.



Invisio

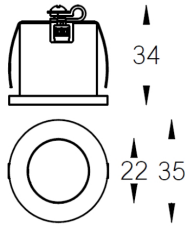

**05000000201** ■ 0 ■ 200  
 2W 188lm 6000K

Led Color	Optics	Finish
C 6000K	12°	W White
N 4000K	24°	B Black
W 3000K	36°	S Silver

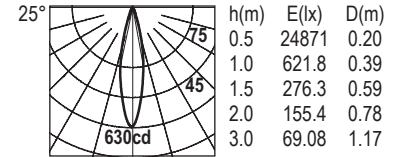

- Recessed fixed capsule light ideal for ceiling and for installation in furniture
- Construction in machined aluminium
- Powder coated for corrosion resistance
- Dimmable for brightness control via 0 to 10V, 1 to 10V, potentiometer, phase cut

- Extruded aluminium for better heat sink of LED
- Fixture holding system using SS-304 fastening TRI clip
- Strain relief cable clamp with quick connect LED harness
- Ceiling thickness 3 to 30mm

- Wire for mains supply cable 2c×1.5mm<sup>2</sup>
- Reiz Electronic LED driver constant current remote 24V, THD<10%, PF>0.95
- LED consistent to 4macadam ellipse
- LED CRI : 85

Gola Micro

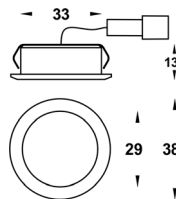

**21800000201** ■ 000 ■ 300  
 2W 138lm 6000K  
 Cut Off Angle : 20° Optics : 90°

Led Color	Finish
C 6000K	W White
N 4000K	B Black
W 3000K	S Silver

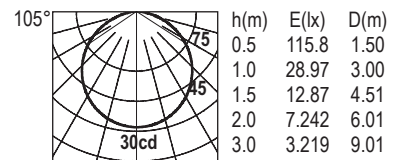

- Recessed fixed low profile diffused down light for cabinet lights
- Construction in CNC machined aluminium frame
- Dimmable for brightness control via 0 to 10V, 1 to 10V, potentiometer, phase cut
- High efficiency PMMA diffuser

- Powder coated for corrosion resistance.
- Fixture holding system using stainless Steel -304 fastening clip.
- Strain relief cable clamp with quick connect LED harness
- Extruded aluminium for better heatsink of LED
- Ceiling thickness 5 to 30mm

- Wire for mains supply cable up to 2c×1.5 mm<sup>2</sup>.
- Reiz Electronic LED driver constant current 24dc remote, THD<10%, PF>0.95
- LED consistent to 4macadam ellipse
- LED CRI : 85



## Gola Mini Lensed

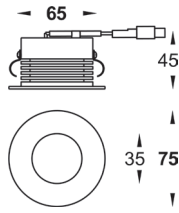

**0530000801** 1 200  
 8W 628lm 6000K  
 Cut Off Angle : 45°  
 Led Color Optics Finish  
 C 6000K 12° W White  
 N 4000K 24° B Black  
 W 3000K 36° S Silver

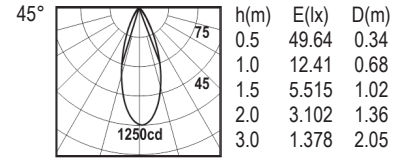

- Recessed fixed capsule light ideal for ceiling and for installation in furniture
- Construction in CNC machined aluminium frame
- Powder coated for corrosion resistance.

- Fixture holding system using stainless Steel -304 fastening clip.
- Strain relief cable clamp with quick connect LED harness
- Extruded aluminium for better heatsink of LED
- Ceiling thickness 3 to 30mm

- Wire for mains supply cable up to 2c×1.5 mm².
- Reiz Electronic LED driver constant current 24dc remote, THD<10%, PF>0.95
- LED consistent to 4macadam ellipse
- LED CRI : 85

## Cavern

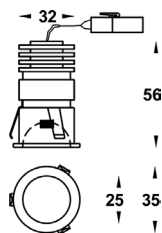

**2100000201** 000 200  
 2W 165lm 6000K  
 Cut Off Angle : 30° Optics : 45°  
 Led Color Finish  
 C 6000K W White  
 N 4000K B Black  
 W 3000K S Silver

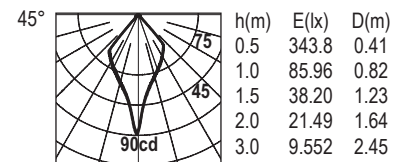

- Recessed fixed LED downlighter for hotels & retail in cabinet
- Construction in extruded CNC machined aluminium
- powder coated for corrosion resistance
- Fixture holding system using SS-304 fastening TRI clip

- Dimmable for brightness control via 0 to 10V, 1 to 10V, potentiometer, phase cut
- Strain relief cable clamp with quick connect LED harness
- Extruded aluminium for better heatsink of LED
- Ceiling thickness 3 to 30mm
- Wire for mains supply cable 2c×1.5mm²

- Reiz Electronic LED driver constant current remote, THD<10%, PF>0.95
- LED consistent to 4macadam ellipse
- LED CRI : 85

Torch Mini

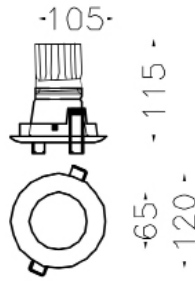

**2000000801** 0 200  
 8W 722lm 6000K  
 Cut Off Angle : 54°

Led Color	Optics	Finish
C 6000K	12°	W White
N 4000K	24°	B Black
W 3000K	36°	S Silver

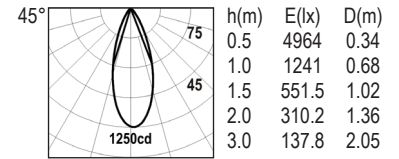

- Deep recessed fixed down light in torch shape
- Construction in die-cast aluminium frame
- Powder coated for corrosion resistance
- Fixture holding system using SS-304 fastening springs
- Extruded aluminium for better heatsink of LED

- Dimmable for brightness control via 0 to 10V, 1 to 10V, potentiometer, phase cut
- Ceiling thickness 3 to 30mm
- Strain relief cable clamp with quick connect LED harness
- Wire for mains supply cable 2c×1.5mm<sup>2</sup>

- Reiz Electronic LED driver constant current integrated, THD<10%, PF>0.95
- LED consistent to 4macadam ellipse
- LED CRI : 85

Shower

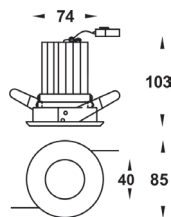

**0570000801** 1 300  
 8W 665lm 6000K  
 Cut Off Angle : 25°

Led Color	Optics	Finish
C 6000K	12°	W White
N 4000K	24°	B Black
W 3000K	36°	S Silver

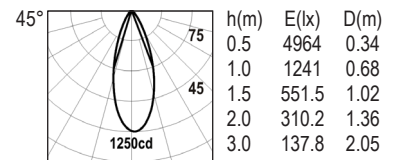

**0570000204** 1 300  
 12W 1000lm 6000K  
 Cut Off Angle : 25°

Led Color	Optics	Finish
C 6000K	12°	W White
N 4000K	24°	B Black
W 3000K	36°	S Silver

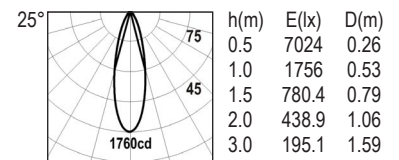

**0570000207** 1 300  
 16W 1260lm 6000K  
 Cut Off Angle : 25°

Led Color	Optics	Finish
C 6000K	12°	W White
N 4000K	24°	B Black
W 3000K	36°	S Silver

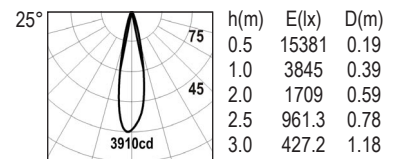

- Low glare fixed downlight for wet locations with tempered safety glass
- Construction in die-cast aluminium and pressed steel frame
- Powder coated for corrosion resistance
- Two parts mounting for easy installation and maintenance

- Dimmable for brightness control via 0 to 10V, 1 to 10V, potentiometer, phase cut
- Fixture holding system using SS-304 fastening wings
- Extruded aluminium for better heatsink of LED
- Ceiling thickness 3 to 30mm
- Strain relief cable clamp with quick connect LED harness

- Wire for mains supply cable 2c×1.5mm<sup>2</sup>
- Reiz Electronic LED driver constant current integrated, THD<10%, PF>0.95
- LED consistent to 4macadam ellipse
- LED CRI : 85

Ghost

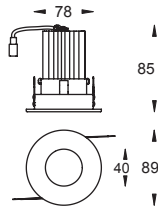

**12905300801** 1 200  
 8W 650lm 6000K  
 Cut Off Angle : 40°

Led Color	Optics	Finish
C 6000K	12°	W White
N 4000K	24°	B Black
W 3000K	36°	S Silver

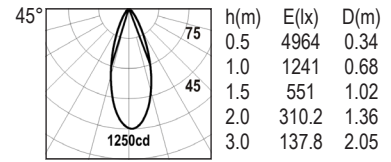

**12905300204** 1 200  
 12W 1010lm 6000K  
 Cut Off Angle : 40°

Led Color	Optics	Finish
C 6000K	12°	W White
N 4000K	24°	B Black
W 3000K	36°	S Silver

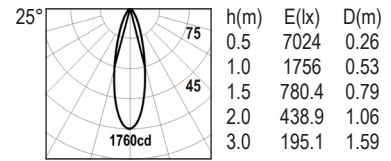

- Recessed fixed down lighting flat trim round aperture for a deep recessed glare free light
- Construction in die-cast aluminium flat trim
- Powder coated for corrosion resistance
- Two parts mounting for easy installation and maintenance
- Dimmable for brightness control via 0 to 10V, 1 to 10V, potentiometer, phase cut

- Fixture holding system using stainless steel-304 fastening wings
- Extruded aluminium for better heatsink of LED
- Ceiling thickness 3 to 30mm
- Strain relief cable clamp with quick connect LED harness

- Wire for mains supply cable 2C×1.5mm<sup>2</sup>
- Reiz Electronic LED driver constant current integrated, THD<10%, PF>0.95
- LED consistent to 4macadam ellipse
- LED CRI : 85

Lunia Micro

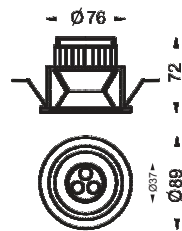

**22919508W00** 1 200  
 8W 562lm 6000K  
 Cut off Angle

Led Color	Optics	Finish
C 6000K	36°	W White
N 4000K		B Black
W 3000K		S Silver

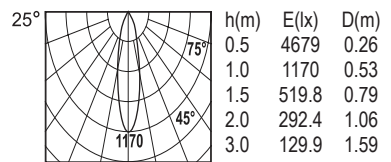

- Low glare deep recessed fixed down light
- Construction in die-cast aluminium
- Round Gimble frame on a compass fitting mechanism adjustable ±30° in all directions
- Powder coated for corrosion resistance
- Fixture holding system using stainless steel-304 fastening springs

- Dimmable for brightness control via 0 to 10V, 1 to 10V, potentiometer, phase cut
- Extruded aluminium for better heatsink of LED
- Ceiling thickness 3 to 30mm
- Strain relief cable clamp with quick connect LED harness

- Wire for mains supply cable 2c×1.5mm<sup>2</sup>
- Reiz Electronic LED driver constant current integrated, THD<10%, PF>0.95
- LED consistent to 3macadam ellipse
- LED CRI : 85



Lunia Mini

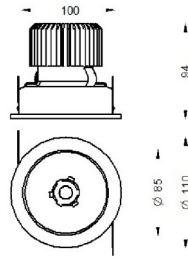

**05505300801** 1 200  
 8W 732lm 6000K  
 Cut Off Angle : 40°  
 Led Color Optics Finish  
 C 6000K 36° W White  
 N 4000K B Black  
 W 3000K S Silver

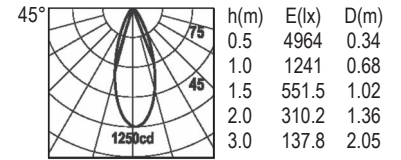

**05505301501** 1 200  
 15W 1380lm 6000K  
 Cut Off Angle : 40°  
 Led Color Optics Finish  
 C 6000K 12° W White  
 N 4000K 24° B Black  
 W 3000K 36° S Silver

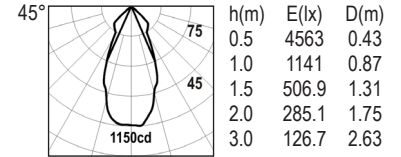

- Low glare deep recessed fixed down light
- Construction in die-cast aluminium frame
- Powder coated for corrosion resistance
- Reflector aluminium 99.9% silver bright anodized
- Fixture holding system using stainless steel-304 fastening springs

- Dimmable for brightness control via 0 to 10V, 1 to 10V, potentiometer, phase cut
- Extruded aluminium for better heatsink of LED
- Ceiling thickness 3 to 30mm
- Strain relief cable clamp with quick connect LED harness

- Wire for mains supply cable 2c×1.5mm<sup>2</sup>
- Reiz Electronic LED driver constant current integrated, THD<10%, PF>0.95
- LED consistent to 4 macadam ellipse
- LED CRI : 85

Trimless Lunia Mini

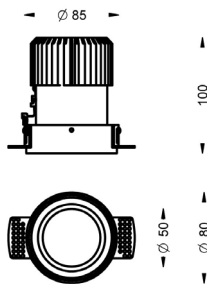
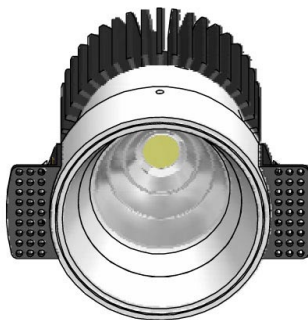

**055054015000** 1 200  
 12W 720lm 3000K  
 Cut Off Angle : 80°  
 Led Color Optics Finish  
 C 6000K W White  
 N 4000K B Black  
 W 3000K S Silver

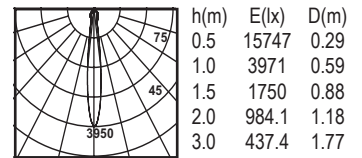

**055054016000** 1 200  
 15W 1086lm 6000K  
 Optics : 80°  
 Led Color Optics Finish  
 C 6000K W White  
 N 4000K B Black  
 W 3000K S Silver

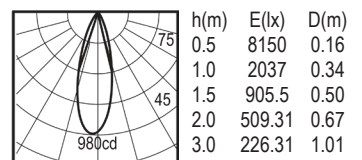

- Low glare deep recessed fixed trimless down light
- Construction in aluminium Frame with 2 point support system.
- Premounting Kit available for ease of installation
- Optional dimmable for brightness control via 0 to 10V, 1 to 10V, potentiometer, phase cut

- Fixture holding system using stainless steel-304 fastening springs/wing
- Extruded aluminium for better heatsink of LED
- Strain relief cable clamp with quick connect LED harness
- Wire for mains supply cable 2c×1.5mm<sup>2</sup>

- Reiz Electronic LED driver constant current integrated, THD<10%, PF>0.95
- LED consistent to 3macadam ellipse
- LED CRI : 85

## Lunia Maxx

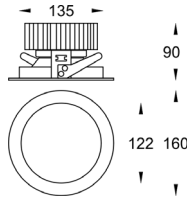

**06109000206 900 2EX**

15W 1384lm 6000K  
Cut Off Angle : 40° Optics : 80°

Led Color	Finish
C 6000K	W White
N 4000K	B Black
W 3000K	S Silver

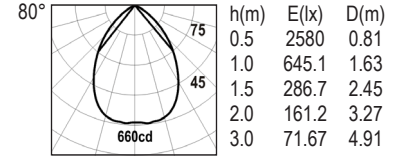

**06109000209 900 2EX**

20W 1810lm 6000K  
Cut Off Angle : 40° Optics : 80°

Led Color	Finish
C 6000K	W White
N 4000K	B Black
W 3000K	S Silver

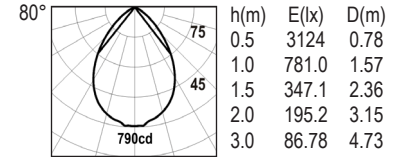

- Low glare deep recessed downlighter for soft downlighting
- Construction in die-cast aluminium frame
- High efficiency PMMA diffuser with 90% transmittance, U.V Stabilized
- Powder coated for corrosion resistance
- Dimmable for brightness control via 0 to 10V, 1 to 10V, potentiometer, phase cut

- Reflector aluminium 99.9% silver bright anodized
- Fixture holding system using SS-304 fastening springs/wing
- Extruded aluminium for better heatsink of LED
- Ceiling thickness 12 to 30mm
- Strain relief cable clamp with quick connect LED harness

- Wire for mains supply cable 2c×1.5mm<sup>2</sup>
- Reiz Electronic LED driver constant current integrated, THD<10%, PF>0.95
- LED consistent to 4macadam ellipse
- LED CRI : 85

## Lunia Maxx Lensed

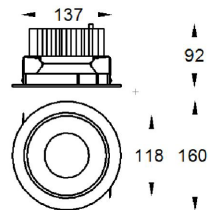

**06109000207 251 20L**

16W 1360lm 6000K

Led Color	Finish
C 6000K	W White
N 4000K	B Black
W 3000K	S Silver

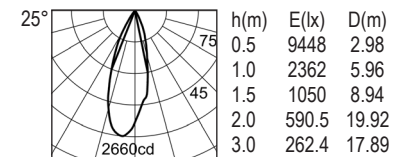

**06109000307 251 20L**

25W 2252lm 6000K

Led Color	Finish
C 6000K	W White
N 4000K	B Black
W 3000K	S Silver



- Low glare deep recessed downlighter for spot lighting
- Construction in die-cast aluminium frame
- Powder coated for corrosion resistance
- Reflector aluminium 99.9% reflective powder coated
- Fixture holding system using SS-304 fastening springs/wing

- Dimmable for brightness control via 0 to 10V, 1 to 10V, potentiometer, phase cut
- Extruded aluminium for better heatsink of LED
- Ceiling thickness 3 to 30mm
- Strain relief cable clamp with quick connect LED harness

- Wire for mains supply cable 2c×1.5mm<sup>2</sup>
- Reiz Electronic LED driver constant current integrated, THD<10%, PF>0.95
- LED consistent to 4macadam ellipse
- LED CRI : 85

## Lunia Mega

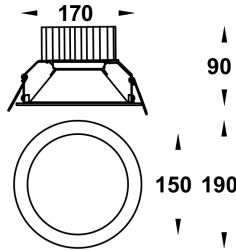

**06207000209 801 200**  
 20W 1810lm 6000K  
 Cut Off Angle : 40° Optics : 80°  
**Led Color** **Finish**  
 C 6000K **W** White  
 N 4000K **B** Black  
 W 3000K **S** Silver

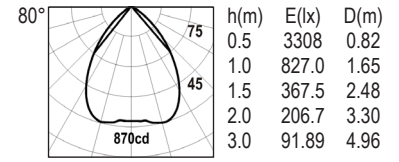

**06207000309 801 200**  
 30W 2700lm 6000K  
 Cut Off Angle : 27° Optics : 80°  
**Led Color** **Finish**  
 C 6000K **W** White  
 N 4000K **B** Black  
 W 3000K **S** Silver

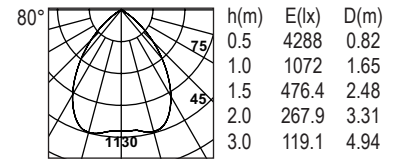

- Low glare fixed downlight with polycarbonate diffuser
- Construction in die-cast aluminium and pressed steel frame
- Powder coated for corrosion resistance
- High efficiency PMMA diffuser with 90% transmittance, U.V Stabilized
- Fixture holding system using SS-304 fastening wings

- Dimmable for brightness control via 0 to 10V, 1 to 10V, potentiometer, phase cut
- Extruded aluminium for better heat sink of LED
- Ceiling thickness 3 to 30mm
- Strain relief cable clamp with quick connect LED harness
- Wire for mains supply cable 2c×1.5mm<sup>2</sup>

- Reiz Electronic LED driver constant current integrated, THD<10%, PF>0.95
- LED consistent to 4macadam ellipse
- LED CRI : 85

## Sun Mini

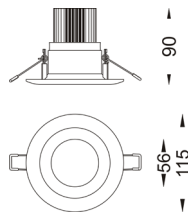

**05605306W09 1W200**  
 6W 548lm 6000K  
 Cut Off Angle : 12°  
**Led Color** **Finish**  
 C 6000K **W** White  
 N 4000K  
 W 3000K

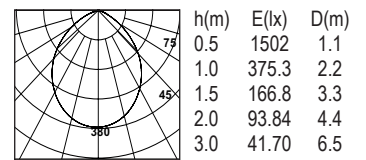

**05605310W09 1W200**  
 10W 904lm 6000K  
 Cut Off Angle : 12°  
**Led Color** **Finish**  
 C 6000K **W** White  
 N 4000K  
 W 3000K

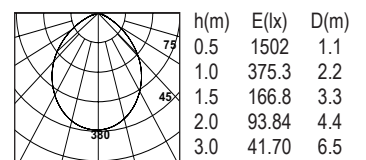

- Recessed downlighter for soft diffused look
- Highly reflective polycarbonate trim and reflector
- Fixture holding system using SS-304 fastening springs/wing
- High efficiency PMMA diffuser with 90% transmittance U.V stabilized

- Extruded aluminium for better heatsink of LED
- Ceiling thickness 5 to 30mm
- Strain relief cable clamp with quick connect LED harness
- Wire for mains supply cable 2c×1.5mm<sup>2</sup>

- Reiz Electronic LED driver constant current integrated, THD<10%, PF>0.95
- LED consistent to 4macadam ellipse
- LED CRI : 85



Sun Mini Quad

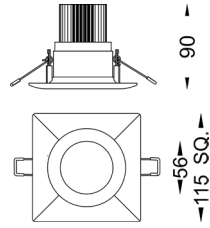

**056S5300801** ■ **CD1W200**  
 6W 543lm 6000K  
 Cut Off Angle : 12°  
**Led Color** **Finish**  
 C 6000K W White  
 N 4000K  
 W 3000K

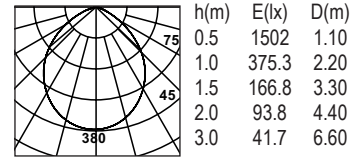

**056Q5310W00** ■ **CD1W200**  
 10W 9023lm 6000K  
 Cut Off Angle : 12°  
**Led Color** **Finish**  
 C 6000K W White  
 N 4000K  
 W 3000K

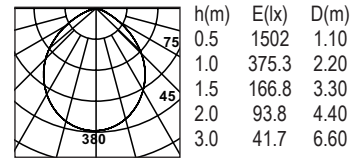

- R ecessed downlighter for soft diffused look
- Highly reflective polycarbonate trim and reflector
- Fixture holding system using SS-304 fastening springs/wing
- Extruded aluminium for better heatsink of LED
- High efficiency PMMA diffuser with 90% transmittance, U.V stabilized

- Dimmable for brightness control via 0 to 10V, 1 to 10V, potentiometer, phase cut
- Ceiling thickness 5 to 30mm
- Strain relief cable clamp with quick connect LED harness
- Wire for mains supply cable 2c×1.5mm<sup>2</sup>

- Reiz Electronic LED driver constant current integrated, THD<10%, PF>0.95
- LED consistent to 4macadam ellipse
- LED CRI : 85

Sun Maxx

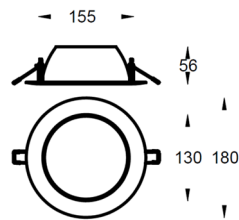

**1810000112** ■ **C11W200**  
 15W 1390lm 6000K  
 Cut Off Angle : 5° Optics : 80°  
**Led Color** **Finish**  
 C 6000K W White  
 N 4000K B Black  
 W 3000K S Silver

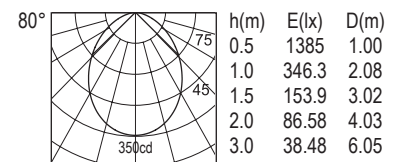

**18100002509** ■ **C11W200**  
 25W 2252lm 6000K  
 Cut Off Angle : 5° Optics : 80°  
**Led Color** **Finish**  
 C 6000K W White  
 N 4000K B Black  
 W 3000K S Silver

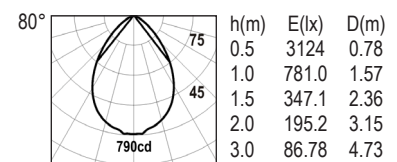

- R ecessed downlighter for soft diffused look
- Highly reflective polycarbonate trim and reflector
- Fixture holding system using SS-304 fastening springs/wing
- High efficiency PMMA diffuser with 90% transmittance, U.V Stabilized

- Dimmable for brightness control via 0 to 10V, 1 to 10V, potentiometer, phase cut
- Extruded aluminium for better heatsink of LED
- Ceiling thickness 5 to 30mm
- Strain relief cable clamp with quick connect LED harness

- Wire for mains supply cable 2c×1.5mm<sup>2</sup>
- Reiz Electronic LED driver constant current integrated, THD<10%, PF>0.95
- LED consistent to 4macadam ellipse
- LED CRI : 85

## Smooth Mini

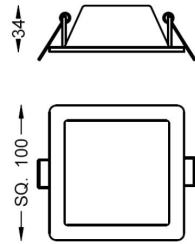
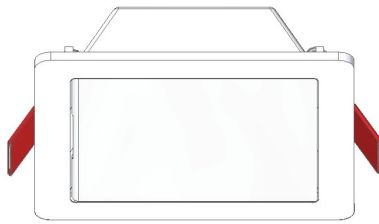

**19516000801** ■ 001 ■ 300  
 15W, 100lm/W 6500K  
 Optics : 100°

<b>Led Color</b>	<b>Finish</b>
C 6000K	W White
N 4000K	B Black
W 3000K	S Silver

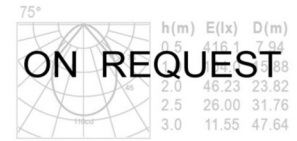

- Recessed luminaire for symmetrical medium to wide beam light distribution for ambient lighting
- Construction double piece molded trims for easy maintenance

- High efficiency acrylic diffuser
- Strain relief cable clamp
- Screw mounting using clamping claws

- Ceiling thickness 3 to 30mm
- Wire for mains supply cable 2c×1.5mm<sup>2</sup>
- Reiz Electronic LED driver integrated, THD<10% PF>0.95

## Smooth Maxx

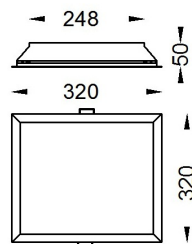
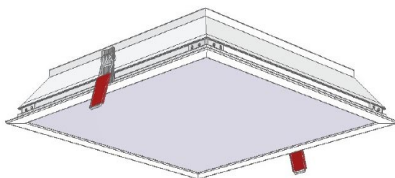

**2082080R281** ■ 001 ■ 300  
 15W 1275lm 6500K  
 Optics : 100°

<b>Led Color</b>	<b>Finish</b>
C 6000K	W White
N 4000K	B Black
W 3000K	S Silver

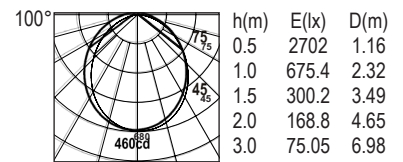

- Recessed luminaire for symmetrical wide beam light distribution for ambient lighting
- Construction in single piece mitered extruded aluminium frame
- High efficiency prismatic diffuser
- High efficiency PMMA diffuser with 90% transmittance, U.V Stabilized

- Dimmable for brightness control via 0 to 10V, 1 to 10V, potentiometer, phase cut
- Powder coated for corrosion resistance
- Strain relief cable clamp with quick connect LED harness
- Ceiling thickness 3 to 30mm

- Wire for mains supply cable 2c×1.5mm<sup>2</sup>
- Reiz Electronic LED driver constant current integrated, THD<10%, PF>0.95
- LED consistent to 4macadam ellipse
- LED CRI : 85

Smooth Mega

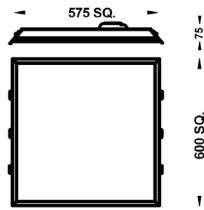

**048095R1596 000 2RC**  
 36W 3302lm 6000K  
 Optics : 100°  
**Led Color**  
 C 6000K  
 N 4000K  
 W 3000K  
**Finish**  
 W White

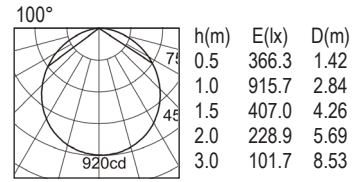

- Recessed luminaire to provide high output diffused light
- Construction in mitered extruded aluminium frame with Polycarbonate diffuser
- High efficiency PMMA diffuser with 90% transmittance, U.V Stabilized
- Powder coated for corrosion resistance

- Dimmable for brightness control via 0 to 10V, 1 to 10V, potentiometer, phase cut
- Extruded aluminium for better heatsink of LED
- Ceiling thickness 3 to 30mm
- Strain relief cable clamp with terminal block
- Wire for mains supply cable 3c×1.5mm<sup>2</sup>

- Mounting Provision for plaster board ceiling is optional
- Reiz Electronic LED driver constant current integrated, THD<10%, PF>0.95
- LED consistent to 4macadam ellipse
- LED CRI : 85



## Recessed Rapier

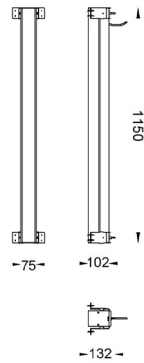
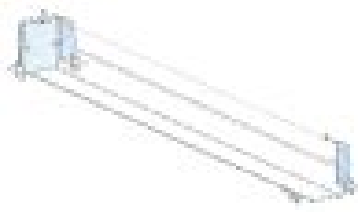

**14809500121** 1 2  
 20W 20184lm 6000K  
 Cut off Angle : 60°  
**Led Color** Finish  
 C 6000K W White  
 N 4000K B Black  
 W 3000K S Silver

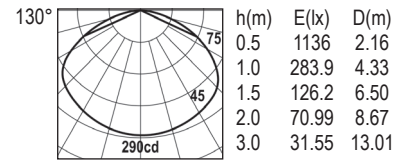

**1480950R572** 1 2  
 40W 3810lm 6000K  
 Cut Off Angle : 60° Optics : 131°  
**Led Color** Finish  
 C 6000K W White  
 N 4000K B Black  
 W 3000K S Silver

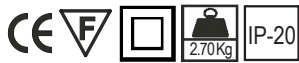
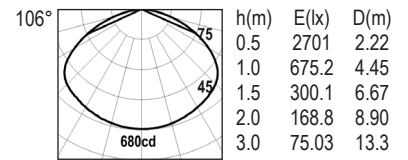

- Recessed LED luminaire for even diffused downward light
- Construction with extruded aluminium for better heatsink of LED
- High efficiency PMMA diffuser with 90% transmittance, U.V Stabilized

- Dimmable for brightness control via 0 to 10V, 1 to 10V, potentiometer, phase cut
- Powder coated for corrosion resistance
- Fixture holding system using MS GP mounting bracket.
- Strain relief cable clamp

- Wire for mains supply cable 3x1.5mm<sup>2</sup>
- Line Joiner to be ordered separately
- Asymmetric option is available also.
- Reiz Electronic LED driver constant current integrated, THD<10%, PF>0.95
- LED CRI : 85

## Trapeze

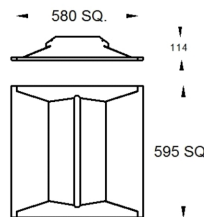
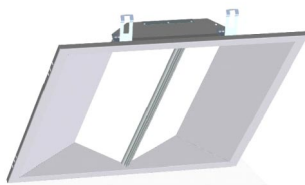

**04809600218** H01 200  
 40W 3600lm 6000K  
 Optics : 100°  
**Led Color** Finish  
 C 6000K W White  
 N 4000K B Black  
 W 3000K S Silver

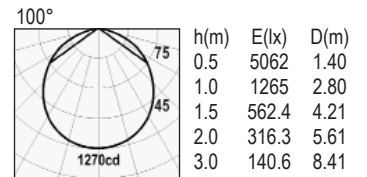

- Recessed luminaire to provide indirect soft lighting in offices
- Pressed metal trim with mitered edges
- Powder coated for corrosion resistance
- Dimmable for brightness control via 0 to 10V, 1 to 10V, potentiometer, phase cut

- White reflector with high total reflectance for maximum light output
- Provision for hanging from ceiling
- Extruded aluminium for better heatsink of LED
- Ceiling thickness 3 to 30mm
- Strain relief cable clamp with terminal block

- Wire for mains supply cable 3x1.5mm<sup>2</sup>
- Reiz Electronic LED driver constant current integrated, THD<10%, PF>0.95
- LED consistent to 4macadam ellipse
- LED CRI : 85

# RECESSED DIRECTIONAL SPOTS

Mostly used for accent lighting, directional spots help give interiors a creative highlight. This enhanced technology based luminaire allows for easy and long lasting swivelling while the recessed and low glare optics ensure visual comfort.



Ghost Ellipse

## Eyelid Micro

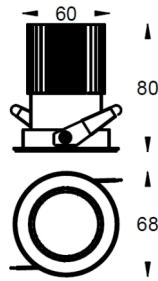

**02300000201** 0 200  
 3W 280lm 6000K  
 Cut off Angle : 50°

Led Color	Optics	Finish
C 6000K	12°	W White
N 4000K	24°	B Black
W 3000K	36°	S Silver

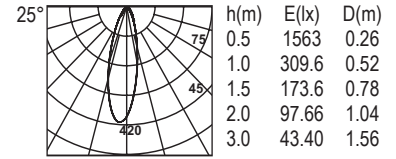

**02300000800** 1 200  
 8W 760lm 6000K

Led Color	Optics	Finish
C 6000K	12°	W White
N 4000K	24°	B Black
W 3000K	36°	S Silver

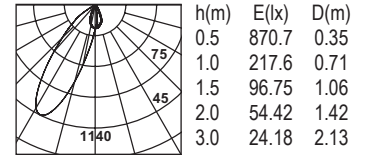

- LED recessed directional down light in flat trim swiveling upto ±30°
- Construction in extruded aluminum frame & ring
- Fixture holding system using stainless steel-304 fastening springs

- Powder coated for corrosion resistance
- Dimmable for brightness control via 0 to 10V, 1 to 10V, potentiometer, phase cut
- Extruded aluminium for better heatsink of LED
- Strain relief cable clamp with quick connect LED harness

- Ceiling thickness 3 to 30mm
- Wire for mains supply cable 2c×1.5mm<sup>2</sup>
- Reiz Electronic LED driver constant current integrated, THD<10%, PF>0.95
- LED CRI : 85

## Eyelid Mini

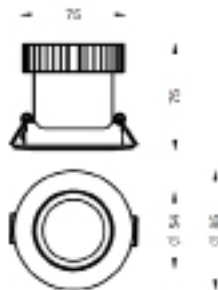

**05400000800** 0 200  
 8W 790lm 6000K

Led Color	Optics	Finish
C 6000K	12°	W White
N 4000K	24°	B Black
W 3000K	36°	S Silver

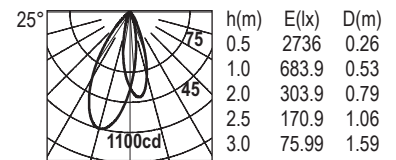

**05400000204** 0 200  
 12W 1105lm 6000K  
 Cut off Angle : 30°

Led Color	Optics	Finish
C 6000K	12°	W White
N 4000K	24°	B Black
W 3000K	36°	S Silver

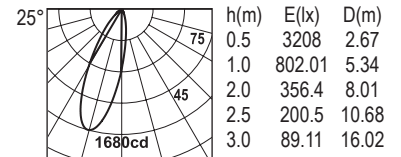

**05400000207** 1 200  
 16W 1492lm 6000K  
 Cut off Angle : 50°

Led Color	Optics	Finish
C 6000K	12°	W White
N 4000K	24°	B Black
W 3000K	36°	S Silver

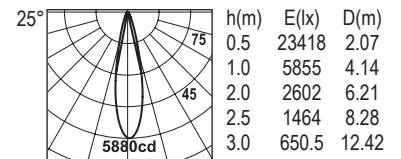

- Recessed downlight in oyster shape swiveling upto ±25° or as a deep recessed concentric
- Construction in die-cast aluminium frame
- Powder coated for corrosion resistance
- Fixture holding system using SS-304 fastening Spring

- Dimmable for brightness control via 0 to 10V, 1 to 10V, potentiometer, phase cut
- Extruded aluminium for better heatsink of LED
- Strain relief cable clamp with quick connect LED harness

- Ceiling thickness 3 to 30mm
- Wire for mains supply cable 2c×1.5mm<sup>2</sup>
- Reiz Electronic LED driver constant current integrated, THD<10%, PF>0.95
- LED CRI : 85

## Ghost 360

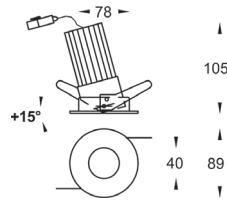

**12905400801** 1 200

8W 730lm 6000K  
Cut off Angle: 31°

Led Color	Optics	Finish
C 6000K	12°	W White
N 4000K	24°	B Black
W 3000K	36°	S Silver

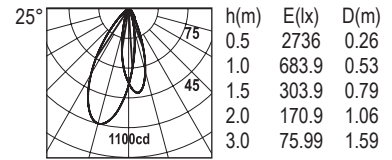

**12905400204** 0 200

12W 1103lm 6000K

Led Color	Optics	Finish
C 6000K	12°	W White
N 4000K	24°	B Black
W 3000K	36°	S Silver

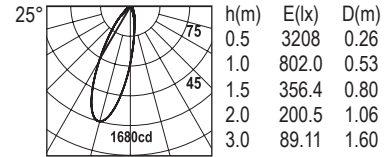

**12905400207** 1 200

16W 1512lm 6000K

Led Color	Optics	Finish
C 6000K	12°	W White
N 4000K	24°	B Black
W 3000K	36°	S Silver

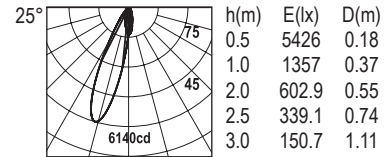

- Recessed directional down lighting flat trim round aperture swiveling up to +170°
- Construction in die-cast aluminium flat trim
- Powder coated for corrosion resistance
- Premounted cylinder for easy installation and maintenance

- Dimmable for brightness control via 0 to 10V, 1 to 10V, potentiometer, phase cut
- Fixture holding system using stainless steel-304 fastening wing
- Extruded aluminium for better heatsink of LED
- Strain relief cable clamp with quick connect LED harness

- Ceiling thickness 3 to 30mm
- Wire for mains supply cable 2c×1.5mm²
- Reiz Electronic LED driver constant current integrated, THD<10%, PF>0.95
- LED CRI : 85

## Ghost Ellipse

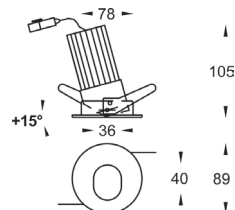

**13005400801** 0 200

8W 742lm 6000K

Led Color	Optics	Finish
C 6000K	12°	W White
N 4000K	24°	B Black
W 3000K	36°	S Silver

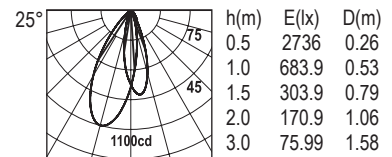

**13005400204** 1 200

12W 1125lm 6500K

Led Color	Optics	Finish
C 6000K	12°	W White
N 4000K	24°	B Black
W 3000K	36°	S Silver

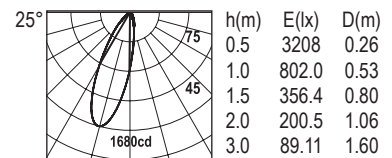

**13005400207** 1 200

16W 1512lm 6000K

Led Color	Optics	Finish
C 6000K	12°	W White
N 4000K	24°	B Black
W 3000K	36°	S Silver

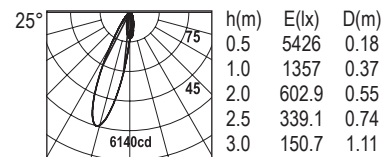

- Recessed directional down light flat trim oval aperture swiveling up to 170°
- Construction in die-cast aluminium flat trim and oval aperture mask Ø48×40
- Powder coated for corrosion resistance
- Pre mounting cylinder for easy installation and maintenance

- Dimmable for brightness control via 0 to 10V, 1 to 10V, potentiometer, phase cut
- Fixture holding system using stainless steel-304 fastening springs
- Extruded aluminium for better heatsink of LED
- Strain relief cable clamp with quick connect LED harness

- Ceiling thickness 3 to 30mm
- Wire for mains supply cable 2c×1.5mm²
- Reiz Electronic LED driver constant current integrated, THD<10%, PF>0.95
- LED CRI : 85



## Lunia Mini D

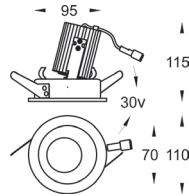

**05505400801** 1 2  
8W 760lm 6000K

Led Color	Optics	Finish
C 6000K	12°	W White
N 4000K	24°	B Black
W 3000K	36°	S Silver

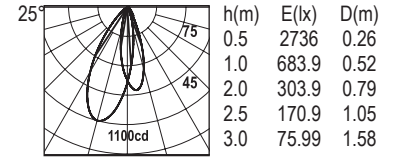

**05505400204** 1 2  
12W 1140lm 6000K

Led Color	Optics	Finish
C 6000K	12°	W White
N 4000K	24°	B Black
W 3000K	36°	S Silver

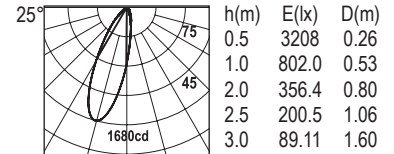

**05505400207** 1 2  
16W 1510lm 6000K

Led Color	Optics	Finish
C 6000K	12°	W White
N 4000K	24°	B Black
W 3000K	36°	S Silver

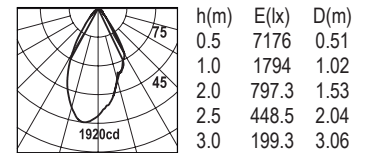

- Low glare deep recessed directional downlight, adjustable system
- Construction in die-cast aluminium frame, double trim design for easy maintenance
- Powder coated for corrosion resistance
- Premount cylinder for easy installation and maintenance

- Dimmable for brightness control via 0 to 10V, 1 to 10V, potentiometer, phase cut
- Reflector aluminium 99.9% silver bright anodized
- Fixture holding system using SS-304 fastening springs
- Extruded aluminium for better heatsink of LED

- Strain relief cable clamp with quick connect LED harness
- Ceiling thickness 3 to 30mm
- Wire for mains supply cable 2c×1.5mm<sup>2</sup>
- Reiz Electronic LED driver constant current integrated, THD<10%, PF>0.95
- LED CRI : 85

## Scoop

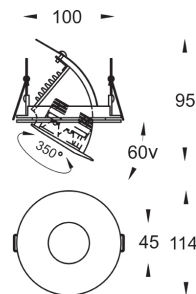

**05905900801** 1 200  
8W 710lm 6000K  
Cut off Angle : 31°

Led Color	Optics	Finish
C 6000K	12°	W White
N 4000K	24°	B Black
W 3000K	36°	S Silver

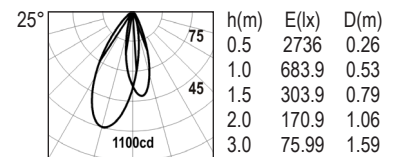

- Recessed adjustable LED downlighter for highlighting walls corners etc.
- Construction in Die-Cast aluminium frame
- Extruded aluminium radiator incorporated for better heatsink of LED
- Fixture holding system using SS-304 fastening springs

- Dimmable for brightness control via 0 to 10V, 1 to 10V, potentiometer, phase cut
- Strain relief cable clamp with quick connect LED harness
- Ceiling thickness 3 to 30mm

- Wire for mains supply cable 2c×1.5mm<sup>2</sup>
- Reiz Electronic LED driver constant current integrated, THD<10%, PF>0.95
- LED CRI : 85



## Trimless Uno Mini

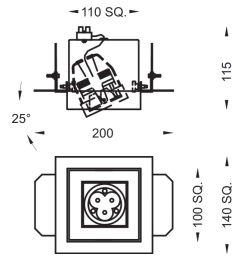
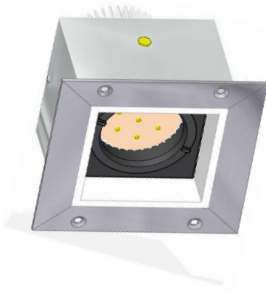

**09013900801** ■ 1 ■ 200  
8W 720lm 6000K

Led Color	Finish
C 6000K	W White
N 4000K	B Black
W 3000K	S Silver

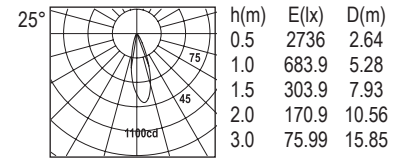

**09013900204** ■ 1 ■ 200  
12W 1102lm 6000K

Led Color	Finish
C 6000K	W White
N 4000K	B Black
W 3000K	S Silver

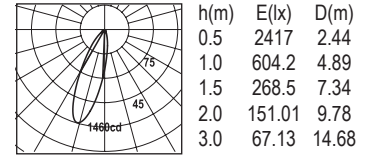

- Low glare deep recessed single square trimless down lighter
- Construction in die-cast aluminium and extruded aluminium frame
- Square gimble inner frame on a compass fitting mechanism adjustable  $\pm 35^\circ$  in single access
- Powder coated for corrosion resistance

- Dimmable for brightness control via 0 to 10V, 1 to 10V, potentiometer, phase cut
- Extruded aluminium for better heatsink of LED
- Ceiling thickness 3 to 30mm
- Strain relief cable clamp with quick connect LED harness

- Wire for mains supply cable  $2c \times 1.5mm^2$
- Reiz Electronic LED driver constant current integrated, THD<10%, PF>0.95
- LED CRI : 85

## Gimble Uno Mini

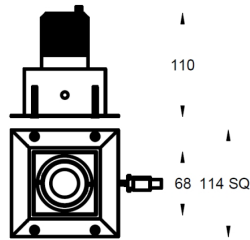
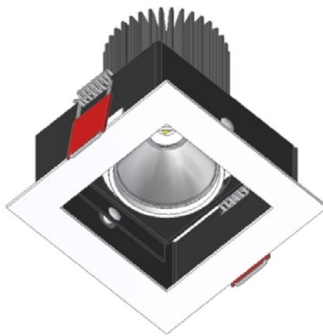

**1950000801** ■ 1 ■ 200  
8W 714lm 6000K

Led Color	Optics	Finish
C 6000K	12°	W White
N 4000K	24°	B Black
W 3000K	36°	S Silver

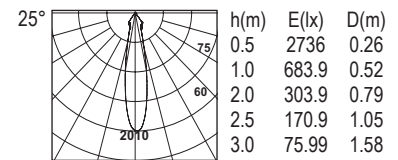

**1950000204** ■ 1 ■ 200  
12W 1090lm 6000K  
Cut off Angle : 25°

Led Color	Optics	Finish
C 6000K	12°	W White
N 4000K	24°	B Black
W 3000K	36°	S Silver

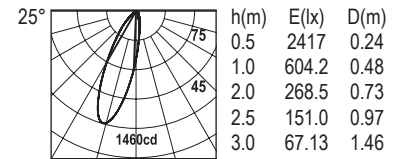

- Low glare deep recessed square down lighter with no internal visible mechanism
- Construction in extruded aluminium
- Square gimble inner frame on a compass fitting mechanism adjustable  $\pm 30^\circ$  in all directions
- Powder coated for corrosion resistance

- Dimmable for brightness control via 0 to 10V, 1 to 10V, potentiometer, phase cut
- Fixture holding system using stainless steel-304 fastening springs
- Extruded aluminium for better heatsink of LED
- Ceiling thickness 3 to 30mm

- Strain relief cable clamp with quick connect LED harness
- Wire for mains supply cable  $2c \times 1.5mm^2$
- Reiz Electronic LED driver constant current integrated, THD<10%, PF>0.95
- LED CRI : 85

## Gimble Duo Mini

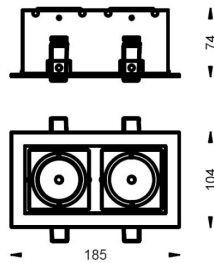

**1960000802** 1 200  
16W 1460lm 6000K

Led Color	Finish
C 6000K	W White
N 4000K	B Black
W 3000K	S Silver

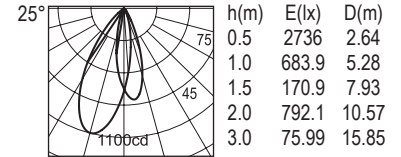

**19600002408** 1 200  
24W 2160lm 6000K

Led Color	Optics	Finish
C 6000K	12°	W White
N 4000K	24°	B Black
W 3000K	36°	S Silver

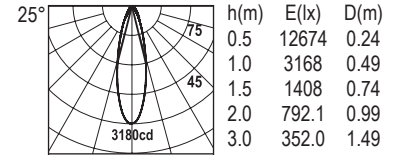

- Low glare deep recessed square down lighter with no internal visible mechanism
- Adjustable double spot light fitted into a aluminium frame
- Powder coated for corrosion resistance
- Dimmable for brightness control via 0 to 10V, 1 to 10V, potentiometer, phase cut

- Extruded aluminium for better heat sink
- Fixture holding system using Stainless Steel -304 fastening spring
- Ceiling thickness 3 to 30mm
- Strain relief cable clamp with quick connect LED harness

- Wire for mains supply cable upto 2c×1.5 mm<sup>2</sup>.
- Reiz electronic LED driver constant current integrated, THD<10% PF>0.95
- LED CRI : 85

## Gimble Trio Mini

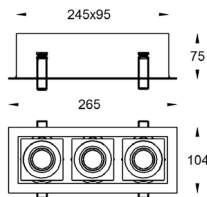
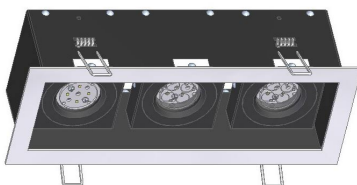

**1970000803** 0 200  
24W 2205lm 6000K

Led Color	Optics	Finish
C 6000K	12°	W White
N 4000K	24°	B Black
W 3000K	36°	S Silver

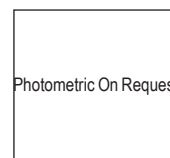

**19700003612** 0 200  
36W 3243lm 6000K

Led Color	Optics	Finish
C 6000K	12°	W White
N 4000K	24°	B Black
W 3000K	36°	S Silver

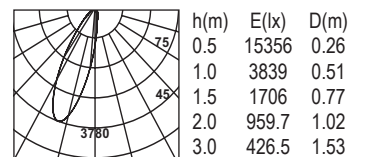

- Adjustable triple spot light fitted into a single piece frame of 3mm steel
- Construction in die-cast aluminium and pressed steel frame
- Square Gimble inner frame on a compass fitting mechanism adjustable ±30° in all directions
- Powder coated for corrosion resistance

- Dimmable for brightness control via 0 to 10V, 1 to 10V, potentiometer, phase cut
- Fixture holding system using stainless steel-304 fastening springs
- Extruded aluminium for better heatsink of LED
- Ceiling thickness 3 to 30mm

- Strain relief cable clamp with quick connect LED harness
- Wire for mains supply cable 2c×1.5mm<sup>2</sup>
- Reiz Electronic LED driver constant current integrated, THD<10%, PF>0.95
- LED CRI : 85

## Gimble Uno Maxx

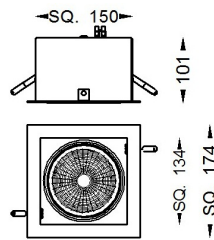
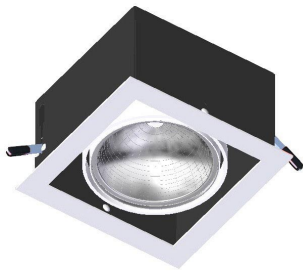

**09000001501** 0 200  
15W 1420lm 6000K

Led Color	Optics	Finish
C 6000K	12°	W White
N 4000K	24°	B Black
W 3000K	36°	S Silver

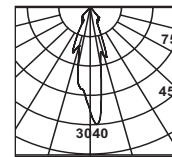

h(m)	E(lx)	D(m)
0.5	10734	0.18
1.0	2684	0.36
1.5	1193	0.54
2.0	670.8	0.73
3.0	298.1	1.09

**09000000212** 0 200  
25W 2260lm 6000K

Led Color	Finish
C 6000K	W White
N 4000K	B Black
W 3000K	S Silver

Photometric On Request



- Adjustable spot light single fitted into a single piece frame of 3mm steel
- Construction in die-cast aluminium and pressed steel frame
- Square gimble inner frame on a compass fitting mechanism adjustable  $\pm 45^\circ$  in all directions
- Powder coated for corrosion resistance

- Dimmable for brightness control via 0 to 10V, 1 to 10V, potentiometer, phase cut
- Fixture holding system claw for positive locking
- Extruded aluminium for better heatsink of LED
- Ceiling thickness 3 to 30mm
- Strain relief cable clamp with quick connect LED

- harness
- Wire for mains supply cable 2c $\times$ 1.5mm<sup>2</sup>
- Reiz Electronic LED driver constant current integrated, THD<10%, PF>0.95
- LED CRI : 85

## Gimble Duo Maxx

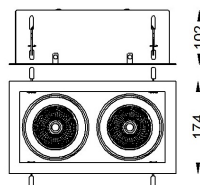

**09100001502** 0 200  
30W 2750lm 6000K

Led Color	Finish
C 6000K	W White
N 4000K	B Black
W 3000K	S Silver

Photometric On Request

**09100000224** 0 200  
50W 4750lm 6000K

Led Color	Finish
C 6000K	W White
N 4000K	B Black
W 3000K	S Silver

Photometric On Request



- Adjustable spot light double fitted into a single piece frame of 3mm steel
- Construction in die-cast aluminium and pressed steel frame
- Square gimble inner frame on a compass fitting mechanism adjustable  $\pm 30^\circ$  in all directions

- Dimmable for brightness control via 0 to 10V, 1 to 10V, potentiometer, phase cut
- Powder coated for corrosion resistance
- Fixture holding system claw for positive locking
- Extruded aluminium for better heatsink of LED
- Ceiling thickness 3 to 30mm

- Strain relief cable clamp with quick connect LED harness
- Wire for mains supply cable 2c $\times$ 1.5mm<sup>2</sup>
- Reiz Electronic LED driver constant current integrated, THD<10%, PF>0.95
- LED CRI : 85

## Gimble Trio Maxx

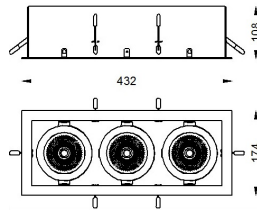

**09200001503** 451 200  
45W 4050lm 2700K

<b>Led Color</b>	<b>Finish</b>
C 6000K	W White
N 4000K	B Black
W 3000K	S Silver

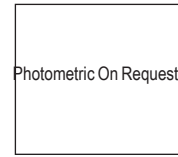

**09200000236** 451 200  
75W 7225K

<b>Led Color</b>	<b>Finish</b>
C 6000K	W White
N 4000K	B Black
W 3000K	S Silver



- Adjustable triple spot light fitted into a single piece frame of 3mm steel
- Construction in die-cast aluminium and pressed steel frame
- Square gimble inner frame on a compass fitting mechanism adjustable  $\pm 30^\circ$  in all directions

- Powder coated for corrosion resistance
- Dimmable for brightness control via 0 to 10V, 1 to 10V, potentiometer, phase cut
- Fixture holding system claw for positive locking
- Extruded aluminium for better heatsink of LED
- Ceiling thickness 3 to 30mm

- Strain relief cable clamp with quick connect LED harness
- Wire for mains supply cable  $2c \times 1.5mm^2$
- Reiz Electronic LED driver constant current integrated, THD<10%, PF>0.95
- LED CRI : 85

## Saturn

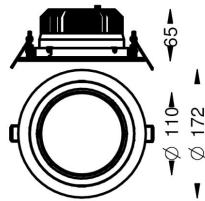
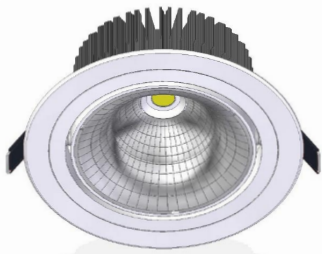

**06100001501** 1 2  
15W 1355lm 6000K

<b>Led Color</b>	<b>Optics</b>	<b>Finish</b>
C 6000K	12°	W White
N 4000K	24°	B Black
W 3000K	36°	S Silver

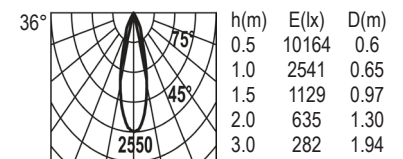

**061000030013** 1 200  
30W 2705lm 6000K

<b>Led Color</b>	<b>Optics</b>	<b>Finish</b>
C 6000K	12°	W White
N 4000K	24°	B Black
W 3000K	36°	S Silver

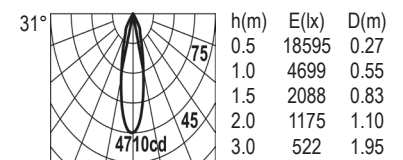

- Adjustable symmetrically, narrow to medium beam for accent lighting of artifacts
- Construction in die-cast aluminium
- Square Gimble frame on a compass fitting mechanism adjustable  $\pm 30^\circ$  in all directions
- Powder coated for corrosion resistance

- Dimmable for brightness control via 0 to 10V, 1 to 10V, potentiometer, phase cut
- Fixture holding system fastening springs
- Extruded aluminium for better heatsink of LED
- Strain relief cable clamp with quick connect LED harness

- Ceiling thickness 3 to 30mm
- Wire for mains supply cable  $2c \times 1.5mm^2$
- Reiz Electronic LED driver constant current integrated, THD<10%, PF>0.95
- LED CRI : 85

## Saturn Maxx

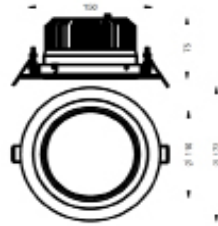

**061M0001501** 1 200  
15W 110lm/W 6000K

Led Color	Finish
C 6000K	W White
N 4000K	B Black
W 3000K	S Silver

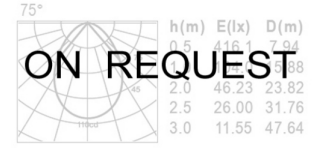

- Adjustable symmetrically, narrow to medium beam for accent lighting of artifacts.
- Round gimble frame on a compass fitting mechanism adjustable 30° in all directions
- Powder coated with high U.V. & corrosion

- resistance.
- Fixture holding system using Stainless Steel-304 fastening wing.
- Extruded aluminum for better heat sink of LED.
- Strain relief cable clamp. Quick connect

- harness for driver
- Ceiling thickness 12 to 30mm.
- Wire for mains supply cable 2c×1.5mm².
- Reiz energy saving LED driver is integrated. THD<10%, PF > 0.95

## Saturn Mini

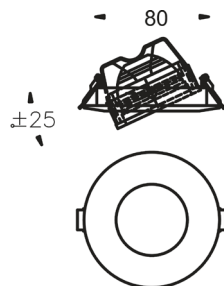

**13104700203** 1 2  
8W 692lm 6000K

Led Color	Optics	Finish
C 6000K	12°	W White
N 4000K	24°	B Black
W 3000K	36°	S Silver

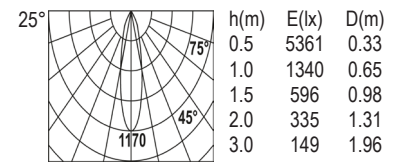

- Adjustable symmetrically, narrow to medium beam for accent lighting of artifacts
- Construction in die-cast aluminium
- Square Gimble frame on a compass fitting mechanism adjustable ±30° in all directions
- Powder coated for corrosion resistance

- Dimmable for brightness control via 0 to 10V, 1 to 10V, potentiometer, phase cut
- Fixture holding system claw for positive locking
- Extruded aluminium for better heatsink of LED
- Strain relief cable clamp with quick connect LED harness

- Ceiling thickness 12 to 30mm
- Wire for mains supply cable 2c×1.5mm²
- Reiz Electronic LED driver constant current integrated, THD<10%, PF>0.95
- LED CRI : 85





Addidas, Sahibabad

# WALLWASHER

A smart lighting technique for even wall washes, low glare recessed spot optimises light throw. Designed for smooth for illumination and easy installation, the fixture can be customised with LED color and finish.



Wash Mini

## Wash Mini

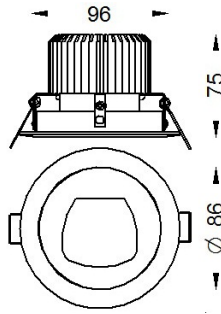
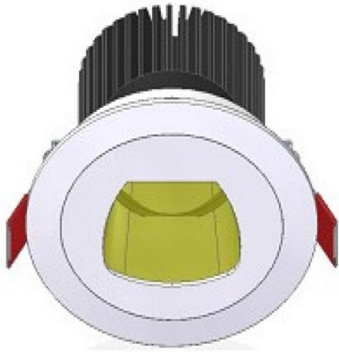

**05512800204** ■ 251 ■ 300  
12W 1150lm 6000K

<b>Led Color</b>	<b>Finish</b>
C 6000K	W White
N 4000K	B Black
W 3000K	S Silver

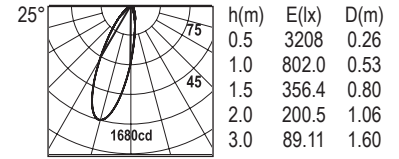

**05512800207** ■ 451 ■ 300  
16W 1440lm 6000K

<b>Led Color</b>	<b>Finish</b>
C 6000K	W White
N 4000K	B Black
W 3000K	S Silver

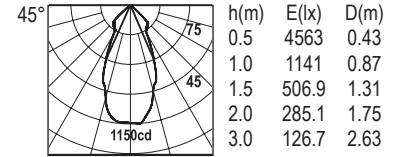

- Low glare recessed downlighter for wallwasher
- Construction in aluminium die-cast frame with two point support system
- Powder coated for corrosion resistance
- Toughened extra clear linear prismatic safety glass
- Reflector aluminium 99.9% silver bright anodized

- Dimmable for brightness control via 0 to 10V, 1 to 10V, potentiometer, phase cut
- Fixture holding system using claw for positive locking stainless steel-304 fastening springs
- Extruded aluminium for better heatsink of LED
- Ceiling thickness 3 to 30mm

- Strain relief cable clamp with quick connect LED harness
- Wire for mains supply cable 2c×1.5mm<sup>2</sup>
- Reiz Electronic LED driver constant current integrated, THD<10%, PF>0.95
- LED CRI : 85

## Wash Maxx

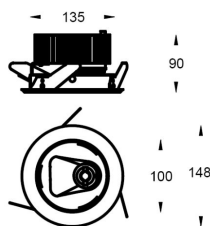
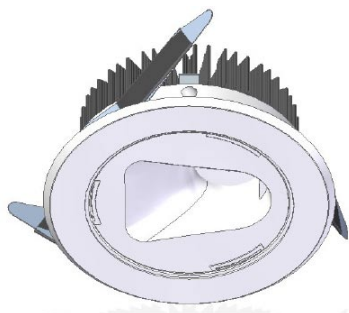

**06116700207** ■ 001 ■ 200  
16W 1530lm 6000K  
Cut of Angle : 50°

<b>Led Color</b>	<b>Finish</b>
C 6000K	W White
N 4000K	B Black
W 3000K	S Silver

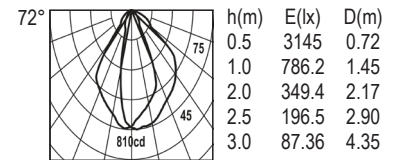

**06116703000** ■ 001 ■ 200  
30W 2860lm 6000K  
Cut of Angle : 50°

<b>Led Color</b>	<b>Finish</b>
C 6000K	W White
N 4000K	B Black
W 3000K	S Silver

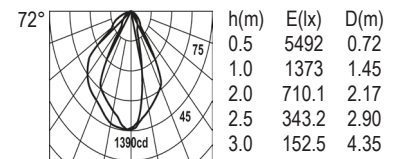

- Low glare recessed downlighter for wallwasher
- Construction in aluminium die-cast frame with two point support system
- Powder coated for corrosion resistance
- Reflector constructed from high reflective polycarbonate efficiency >82%
- Fixture holding system using claw for positive locking stainless steel-304 fastening springs

- Dimmable for brightness control via 0 to 10V, 1 to 10V, potentiometer, phase cut
- Extruded aluminium for better heatsink of LED
- Ceiling thickness 3 to 30mm
- Strain relief cable clamp with quick connect LED harness

- Cree COB LED consistent to 3 macadam ellipse.
- Wire for mains supply cable 2c×1.5mm<sup>2</sup>
- Reiz Electronic LED driver constant current integrated, THD<10%, PF>0.95
- LED CRI : 85





# CEILING MOUNTED DOWNLIGHTS

A set of aesthetically designed downlights that go well with any interior decor. Built on a minimalistic perspective, they are simple and discrete. They are also easy to install and can be customised using LED color and finish.

Kan Nano

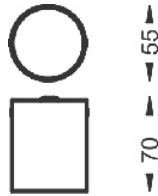

**02000800800 001 200**  
 8W 719lm 6000K  
 Optics : 36° 80° 100°  
**Led Color**  
 C 6000K  
 N 4000K  
 W 3000K  
**Finish**  
 W White  
 B Black  
 S Silver

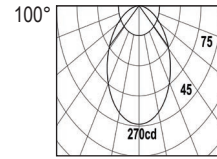

h(m)	E(lx)	D(m)
0.5	1063	104.64
1.0	265.8	209.29
1.5	118.1	313.93
2.0	66.46	418.58
3.0	29.53	627.86



- Surface mounted luminaires for medium beam distribution for ambient lighting for lobbies, entrances, corridors etc
- Construction in single piece, extruded aluminium
- High efficiency PMMA diffuser with 90% transmittance, U.V Stabilized

- Dimmable for brightness control via 0 to 10V, 1 to 10V, potentiometer, phase cut
- Powder coated for corrosion resistance
- White reflector with 98% reflectance
- Extruded aluminium for better heatsink of LED
- Strain relief cable clamp with terminal block
- Wire for mains supply cable upto 2c×1.5mm<sup>2</sup>

- Reiz Electronic LED driver constant current integrated, THD<10%, PF>0.95
- LED consistent to 4 macadam ellipse.
- LED CRI : 85



Versa

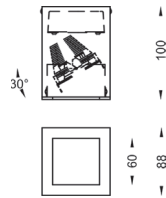

**1150000801** 251 200  
 8W 750lm 6000K  
 Cut of Angle : 40° Optics : 25°  
**Led Color** **Finish**  
 C 6000K W White  
 N 4000K B Black  
 W 3000K S Silver

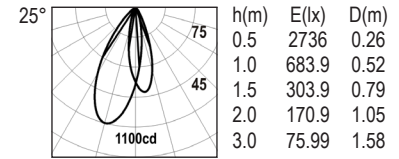

**1150000204** 251 200  
 12W 1160lm 6000K  
 Cut of Angle : 40° Optics : 25°  
**Led Color** **Finish**  
 C 6000K W White  
 N 4000K B Black  
 W 3000K S Silver

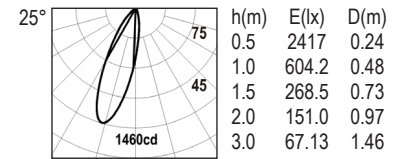

- Surface mounted directional spot with integrated LED driver for a minimalistic look
- Construction in die-casted aluminium and pressed steel frame
- Bracket mounts on a compass fitting mechanism internally and adjustable  $\pm 45^\circ$  in one axis
- Dimmable for brightness control via 0 to 10V, 1 to 10V, potentiometer, phase cut
- Power coated for corrosion resistance
- Lamp & fixture holding system clow for positive locking using stainless steel-304 fastening springs
- Strain relief cable clamp with terminal block
- Extruded aluminium for better heatsink of LED
- Wire for mains supply cable  $2c \times 1.5 \text{ mm}^2$
- Reiz Electronic LED driver constant current integrated, THD<10%, PF>0.95
- LED CRI : 85

Versa 360

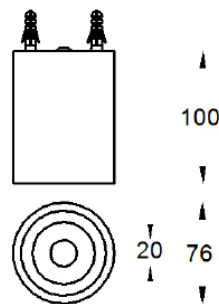

**1320000801** 251 200  
 8W 750lm 6000K  
 Cut of Angle : 40° Optics : 25°  
**Led Color** **Finish**  
 C 6000K W White  
 N 4000K B Black  
 W 3000K S Silver

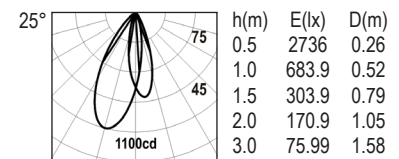

**1320000204** 251 200  
 12W 1160lm 6000K  
 Cut of Angle : 40° Optics : 25°  
**Led Color** **Finish**  
 C 6000K W White  
 N 4000K B Black  
 W 3000K S Silver

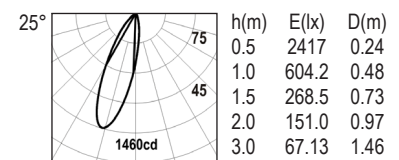

- Surface mounted directional spot with integrated LED driver for a minimalistic look
- Construction in die-casted aluminium and pressed steel frame
- Bracket mounts on a compass fitting mechanism internally and adjustable  $\pm 45^\circ$  in one axis
- Dimmable for brightness control via 0 to 10V, 1 to 10V, potentiometer, phase cut
- Power coated for corrosion resistance
- Lamp & fixture holding system clow for positive locking using stainless steel-304 fastening springs
- Strain relief cable clamp with terminal block
- Extruded aluminium for better heatsink of LED
- Wire for mains supply cable  $2c \times 1.5 \text{ mm}^2$
- Reiz Electronic LED driver constant current integrated, THD<10%, PF>0.95
- LED CRI : 85

Boxy Maxx

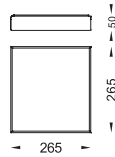

**0011610R348 001 300**  
15W 1460lm 6000K

Led Color	Optics	Finish
C 6000K	12°	W White
N 4000K	24°	B Black
W 3000K	36°	S Silver

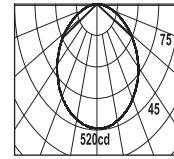

h(m)	E lx	D(cm)
0.5	2051	159.11
1.0	512.7	318.21
1.5	227.8	477.32
2.0	128.1	636.42
3.0	56.97	954.63



- Low Profile Surface mounted wide beam distribution luminaires for ambient lighting for lobbies, entrances, offices etc.
- Construction in extruded aluminium housing
- High efficiency PMMA diffuser with 90% transmittance, U.V Stabilized

- Dimmable for brightness control via 0 to 10V, 1 to 10V, potentiometer, phase cut
- White diffuser for 98% reflectance
- Extruded aluminium for better heatsink of LED
- Strain relief cable clamp with quick connect LED harness

- Wire for mains supply cable 2c×1.5mm<sup>2</sup>
- Reiz Electronic LED driver constant current integrated, THD<10%, PF>0.95
- LED CRI : 85

Boxy Mega

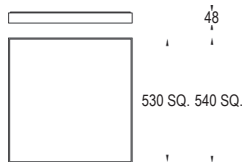

**0011620R396 001 300**  
40W 3860lm 6500K  
Optics : 100°

Led Color	Finish
C 6000K	W White
N 4000K	B Black
W 3000K	S Silver

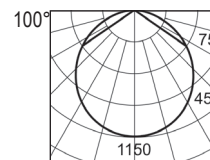

h(m)	E lx	D(m)
0.5	4566	14.49
1.0	1142	28.99
1.5	507.3	43.49
2.0	285.3	57.98
3.0	126.8	86.97



- Suspended luminaire to provide high output wide beam diffused light
- Construction in mitered extruded aluminium frame with Polycarbonate diffuser
- Powder coated corrosion resistance

- Dimmable for brightness control via 0 to 10V, 1 to 10V, potentiometer, phase cut
- Extruded aluminium for better heatsink of LED
- Strain relief cable clamp with terminal block

- Wire for mains supply cable 3c×1.5mm<sup>2</sup>
- Reiz Electronic LED driver constant current integrated, THD<10%, PF>0.95
- LED CRI : 85

# TRACK LUMINAIRES

Track Luminaires are ideal for the retail world where the frequently changing displays demand a flexible lighting system. For greater control of multiple circuits, three phase tracks can be used with various spots. Designed for easy and lasting adjustability they can be personalised using LED color, optics, finish and mounting.



Track Jet

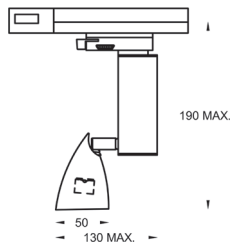

**0040000801** 1 2  
8W 765lm 6000K

Led Color	Optics	Finish
C 6000K	12°	W White
N 4000K	24°	B Black
W 3000K	36°	S Silver

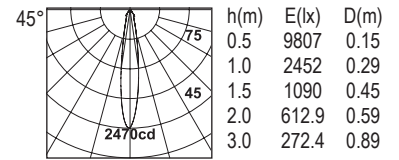

- Low glare directional downlight for track mounting
- Construction in die-cast aluminium and brass
- Powder coated for corrosion resistance

- Dimmable for brightness control via 0 to 10V, 1 to 10V, potentiometer, phase cut
- Lamp housing can rotate 340° for precise directional lighting

- Extruded aluminium for better heatsink of LED
- Reiz Electronic LED driver constant current integrated, THD<10%, PF>0.95
- LED CRI : 85

Catseye

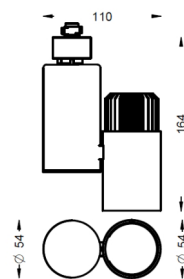
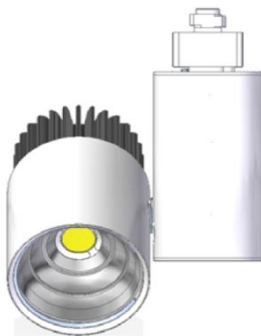

**19215000204** 1 2  
8W 720lm 6000K  
Cut Off Angle : 15°

Led Color	Optics	Finish
C 6000K	12°	W White
N 4000K	24°	B Black
W 3000K	36°	S Silver

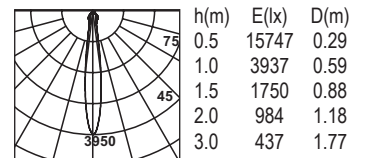

**19215000204** 1 2  
12W 1180lm 6000K  
Cut Off Angle : 15°

Led Color	Optics	Finish
C 6000K	12°	W White
N 4000K	24°	B Black
W 3000K	36°	S Silver

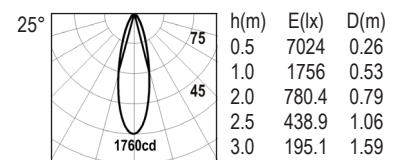

- Main voltage single or 3phase track, surface mounted light providing flexible & directional light with a narrow and medium beam for accent lighting in museum, exhibition, art galleries & retail areas

- Dimmable for brightness control via 0 to 10V, 1 to 10V, potentiometer, phase cut
- Self-locking system at swivel 350 and tilt 90°
- Manufactured from die-cast aluminium
- Powder coated for corrosion

- Extruded aluminium for better heatsink of LED
- Wire for mains supply cable 3c×1.5mm<sup>2</sup>
- Reiz Electronic LED driver constant current integrated, THD<10%, PF>0.95
- LED CRI : 85

## Catseye Maxx

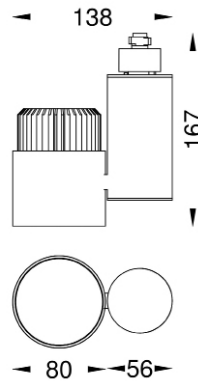

**19216015W04** 1 2 MA

15W 110lm/W 6000K  
Cut Off Angle : 15°

Led Color	Optics	Finish
C 6000K	12°	W White
N 4000K	24°	B Black
W 3000K	36°	S Silver

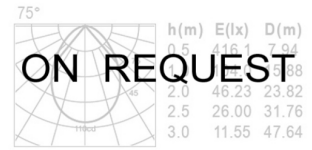

- Main voltage single or 3phase track, surface mounted light providing flexible & directional light with a narrow and medium beam for accent lighting in museum, exhibition, art galleries & retail areas

- Dimmable for brightness control via 0 to 10V, 1 to 10V, potentiometer, phase cut
- Self-locking system at swivel 350 and tilt 90°
- Manufactured from die-cast aluminum
- Powder coated for corrosion

- Extruded aluminium for better heatsink of LED
- Wire for mains supply cable 3c×1.5mm<sup>2</sup>
- Reiz Electronic LED driver constant current integrated, THD<10%, PF>0.95
- LED CRI : 85

## Sun Spot

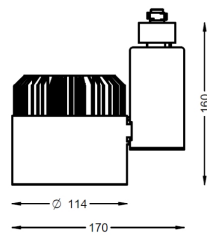

**19017700209** 1 2

20W 1812lm 6000K  
Cut Off Angle : 5°

Led Color	Optics	Finish
C 6000K	12°	W White
N 4000K	24°	B Black
W 3000K	36°	S Silver

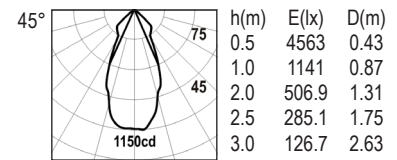

**19017703009** 1 2

30W 2712lm 6000K  
Cut Off Angle : 5°

Led Color	Optics	Finish
C 6000K	12°	W White
N 4000K	24°	B Black
W 3000K	36°	S Silver

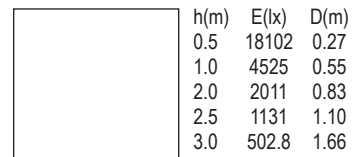

- Main voltage single phase and 3 phase track-mounted light providing flexible & directional light with a narrow, medium and wide beam for accent lighting in museum, exhibition, art galleries & retail areas
- Self-locking system at swivel 350 & tilt 90°

- Dimmable for brightness control via 0 to 10V, 1 to 10V, potentiometer, phase cut
- Manufactured from die-cast aluminum
- Powder coated for resistance & corrosion
- Reflector aluminium 99.9% silver bright anodized

- Extruded aluminium for better heatsink of LED
- Wire for mains supply cable 3c×1.5mm<sup>2</sup>
- Reiz Electronic LED driver constant current integrated, THD<10%, PF>0.95
- LED CRI : 85



GUEST HALL PARK CIRCUS KOLKATA

**INOX**

400  
SCHEMES  
COUNTING

# Mains Voltage Track

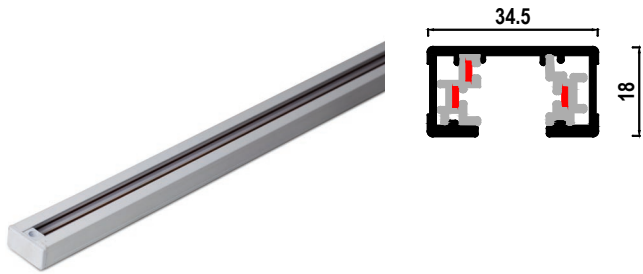

- Heavy Duty mains voltage track
- Live end connector terminal block rated for 25 amperes
- Dual locking spot adaptor rated for 10 amperes alongwith a spring loaded earth clip
- The track has pre-punched holes for fixation. Available in lengths of 1 meter, 2 meters and 3 meters
- Spot adaptor can accept maximum mechanical force of 25 Kilograms; These are with spot & glass heads
- Rectangular bus bar technology maximum area of contact, using 99.9% pure copper rated for 25 amperes load
- Available in lengths of 1 meter, 2 meters and 3 meters
- Reiz spots are available in four different colors
- All housings can withstand high temperatures and are made from Fire Retardant polycarbonate as per UL9V0 standards
- The aluminium track is also the earth conductor
- Lamps Compatible : All types
- Single phase track lights working on 240 VAC can be extended via couplers to any length, limited only by the total system voltage of 5000VA.
- Reiz Spots are available on page nos 39 & 40
- Track can be suspended to a custom drop below the ceiling by ordering the track extension system

04100000010000 ■ 200 ▶  
MV Track  
Length = 1meter

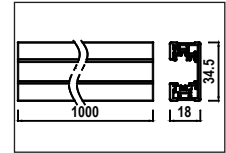

04100000020000 ■ 200 ▶  
MV Track  
Length = 2meter

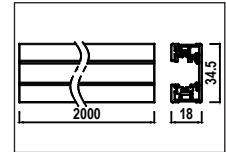

04100000030000 ■ 300 ▶  
MV Track  
Length = 3meter

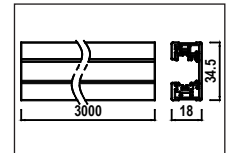

044000000LF0000 ■ 200 ▶  
MV Live End Left  
044000000RT0000 ■ 200 ▶  
MV1 Live End Right

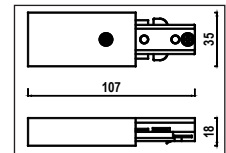

045000000NC0000 ■ 200 ▶  
MV Straight Coupler  
Non Conductive

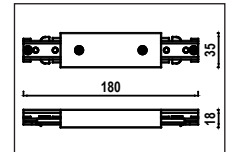

RPCTSPLC0108035A ■ H0 ▶  
MV Single Phase L Coupler Inside  
046000000.02 ■ ▶  
MV1 L Coupler Outside

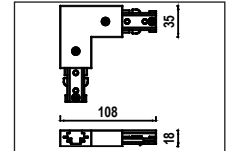

RPCTSPTC0180180A ■ H0 ▶  
MV Single Phase T Coupler Left  
047000000.02 ■ ▶  
MV T Coupler Right

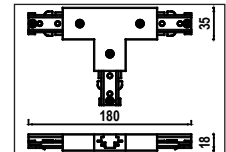

RPCTSPXC0180180A ■ H0 ▶  
MV Single Phase X Coupler

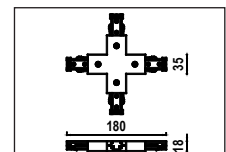

0490000000000000 ■ 200 ▶  
MV Dead End

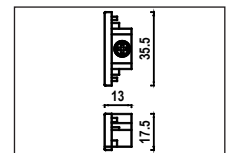

050000000. ■ ▶  
MV Spot Adaptor

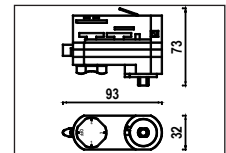

# 3~Phase Track



- The Reiz 3 circuit track for surface mounting is a 5-conductor track with three separately switchable circuits. It consists of an extruded aluminium profile, which also functions as earth, and an inserted plastic profile carrying 4 embedded 3 mm square copper conductors. The track can easily be cut to length on site. It is not necessary to cut or bend back the copper wire
- Spot connectors can accept maximum mechanical force of 25 Kilograms; these are integrated spot & glass head
- The track has pre-punched holes for fixation. Available in lengths of 1 meter, 2 meters and 3 meters
- The aluminium track is also the earth conductor
- The 3 circuit track fulfills the requirements of IEC 570 (VDE 0711, section 300/09.91) for 250V 16A and may be used within hand reach
- 3 circuit tracks can be combined with electronic low voltage tracks and low voltage high profile tracks by means of cubes or flexible corners for various geometry of track types
- 3 phase track lights working on 240 VAC can be extended via couplers to any length, limited only by the total system voltage of 5000VA.
- Reiz Spots are available on page nos 39 & 40
- Track can be suspended to a custom drop below the ceiling by ordering the track extension system

TKMV31M0000000000 0 ▶  
MV3 Track  
Length = 1meter

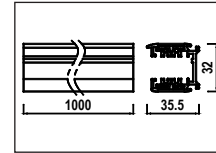

TKMV32M0000000000 0 ▶  
MV3 Track  
Length = 2meter

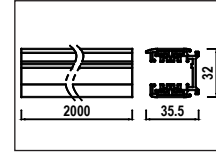

TKMV33M0000000000 0 ▶  
MV3 Track  
Length = 3meter

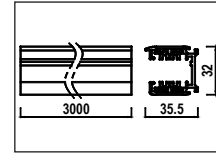

RPCTTPMJ0068031A 0 ▶  
MV3 Track Joiner Left  
33.2. ▶  
MV3 Track Joiner Right

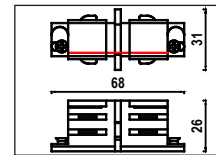

RPCTTPLE0100032B 0 ▶  
MV3 Live End Left  
34.2 ▶  
MV3 Live End Right

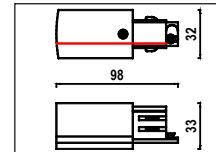

RPCTTPSC0165032B 0 ▶  
MV3 Straight Coupler

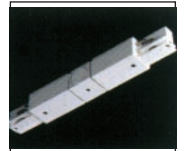
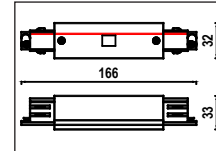

RPCTTPLC0100100A 0 ▶  
MV3 L Coupler Inside  
36.2 ▶  
MV3 L Coupler Outside

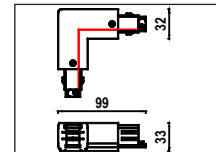

RPCTTPTC0165100B 0 ▶  
MV3 T Coupler Left  
37.2 ▶  
MV3 T Coupler Right

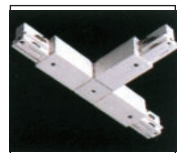
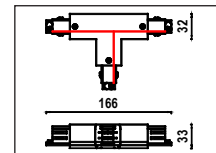

RPCTTPXC0165165A 0 ▶  
MV3 X Coupler

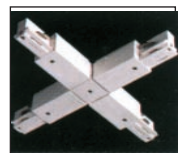
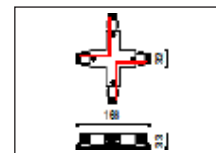

TKMV3DE0000000000 0 ▶  
MV3 Dead End

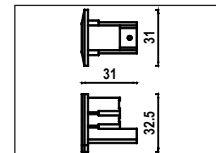

40. ▶  
MV3 Spot Adaptor

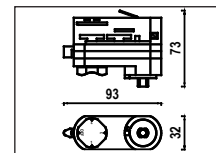

# WALL MOUNTED

Minimalistic design to merge with modern interiors with direct-indirect lighting giving soft diffuse light. They can be personalised using LED color, optics & finish.



Wave

Jet

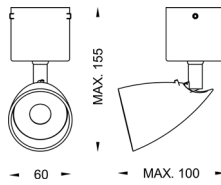

**0040000801** 1 200  
 8W 775lm 6000K  
 Cut Off Angle : 30°  
**Led Color**   **Optics**   **Finish**  
 C 6000K   12°   W White  
 N 4000K   24°   B Black  
 W 3000K   36°   S Silver

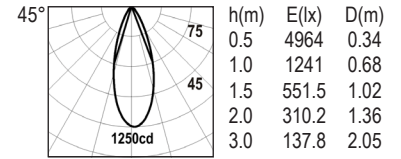

- LED spot luminaire directional up to 100° and swiveling up to 340°
- Construction in Die-cast aluminium and pressed aluminium frame
- Powder coated for corrosion resistance

- Dimmable for brightness control via 0 to 10V, 1 to 10V, potentiometer, phase cut
- Pressure die cast aluminium for better heatsink of LED
- Strain relief cable clamp with terminal block

- Wire for mains supply cable 3C×1.5mm<sup>2</sup>
- Reiz Electronic LED driver constant current integrated, THD<10%, PF>0.95
- LED CRI : 85

Traffic



**00401600205** 001 200  
 12W 1090lm 6000K  
**Led Color**   **Finish**  
 C 6000K   W White  
 N 4000K   B Black  
 W 3000K   S Silver

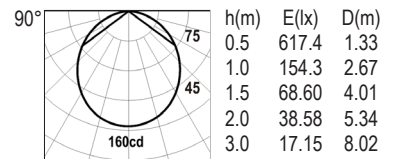

- Low profile diffused light ideal for mirrors, cabinets and retail areas
- Construction in pressed metal sheet and aluminium
- High efficiency PMMA diffuser.

- Powder coated for corrosion resistance
- Dimmable for brightness control via 0 to 10V, 1 to 10V, potentiometer, phase cut
- Extruded aluminium for better heatsink of LED
- Strain relief cable clamp with terminal block

- Wire for mains supply cable 3C×1.5mm<sup>2</sup>
- Reiz Electronic LED driver constant current integrated, THD<10%, PF>0.95
- LED CRI : 85



## Light Saber

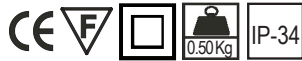
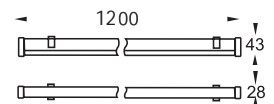
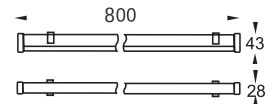
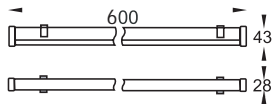
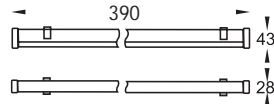

### 01200001000 001S2B0

6W 554lm 6000K  
Cut Off Angle : 5°

Led Color		Finish	
C	6000K	W	White
N	4000K	B	Black
W	3000K	S	Silver

### 01200001000 001S2B0

9W 815lm 6000K  
Cut Off Angle : 5°

Led Color		Finish	
C	6000K	W	White
N	4000K	B	Black
W	3000K	S	Silver

### 01200001800 001S2B0

16W 1413lm 6000K  
Cut Off Angle : 5°

Led Color		Finish	
C	6000K	W	White
N	4000K	B	Black
W	3000K	S	Silver

### 01200001800 001S2B0

20W 2050lm 6000K  
Cut Off Angle : 5° Optics : 121°

Led Color		Finish	
C	6000K	W	White
N	4000K	B	Black
W	3000K	S	Silver

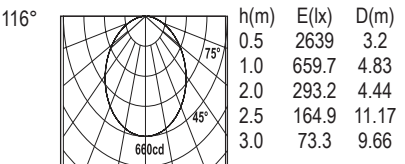
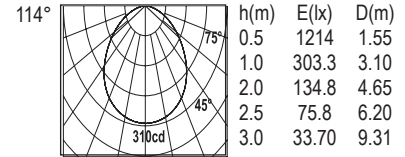
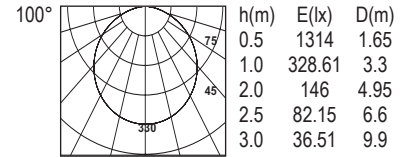
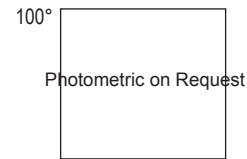

- Elementary sleek diffuse LED luminaire for mounting in general areas and covers
- Construction in extruded aluminium channel with Polycarbonate molded end caps
- Premounting polycarbonate Bracket for easy snap in installation

- Loop in loop out connectors for easy daisy chain connectors
- Dimmable for brightness control via 0 to 10V, 1 to 10V, potentiometer, phase cut

- Reiz Electronic LED driver constant current integrated, THD<10%, PF>0.95
- LED consistent on 2 macadam ellips
- LED CRI : 85

## Light Saber Day Light Harvest

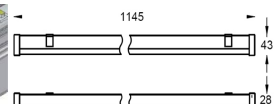
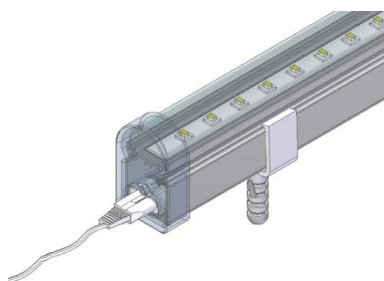

### 01200001800 001S2B0

20W 2050lm 6000K  
Cut Off Angle : 5° Optics : 121°

Led Color		Finish	
C	6000K	W	White
N	4000K	B	Black
W	3000K	S	Silver

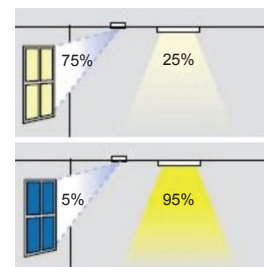
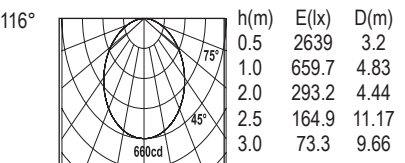

- Elementary Sleek fluorescent luminaire for mounting in general areas and covers.
- Light output will be increase or decrease according day light
- Construction in extruded polycarbonate channel with P.C. molded end caps.

- Pre mounting Polycarbonate Bracket for easy snap in installation.
- Loop in loop out connectors for easy daisy chain connectors

- Strain relief cable clamp with terminal block.
- Wire for mains supply cable upto 2c×1.5mm<sup>2</sup>.
- Reiz energy saving electronic transformer is integrated, THD 10%, PF 0.95.

## Light Baton

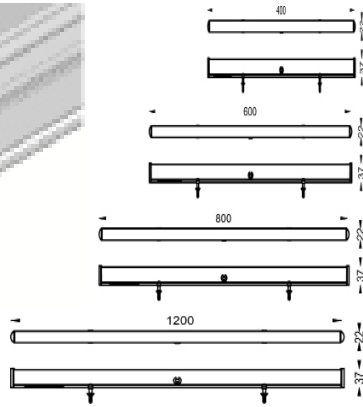
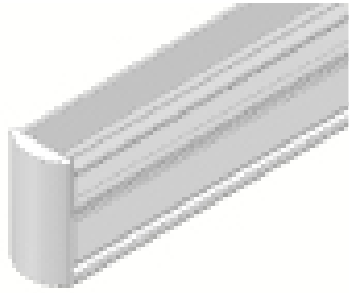

**3200000724 001 500**  
7W 355lm 6000K

Led Color	Finish
C 6000K	W White
N 4000K	B Black
W 3000K	S Silver

**32000001524 001 500**  
15W 1050lm 6000K

Led Color	Finish
C 6000K	W White
N 4000K	B Black
W 3000K	S Silver

**32000001524 001 500**  
15W 1050lm 6000K

Led Color	Finish
C 6000K	W White
N 4000K	B Black
W 3000K	S Silver

**32000001524 001 500**  
15W 1050lm 6000K

Led Color	Finish
C 6000K	W White
N 4000K	B Black
W 3000K	S Silver

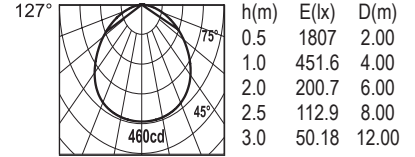

- Elementary Sleek fluorescent luminaire for mounting in general areas and coves.
- Polycarbonate channel with molded end caps.
- Reiz constant Voltage electronic driver is remote

- Fixture holding system using mounting clip.
- Strain relief cable clamp with quick connect LED harness
- LED constant to 2 macadam ellipse

- Reiz Electronic LED driver constant current integrated, THD<10%, PF>0.95
- LED CRI : 85

## I Light

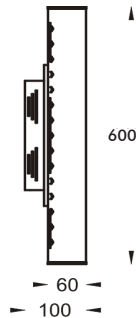

**13501400115 001 200**  
15W, 1380lm 6000K

Led Color	Finish
C 6000K	W White
N 4000K	B Black
W 3000K	S Silver

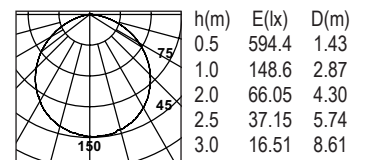

- Soft diffused light to accentuate pillars, corridors and living areas
- Construction in pressed steel sheet and diffused OPAL polycarbonate pipe
- Powder coated for corrosion resistance

- Dimmable for brightness control via 0 to 10V, 1 to 10V, potentiometer, phase cut
- Extruded aluminium for better heatsink of LED
- Strain relief cable clamp with terminal block

- Wire for mains supply cable 3x1.5mm<sup>2</sup>
- Reiz Electronic LED driver constant current integrated, THD<10%, PF>0.95
- LED CRI : 85

Kendo

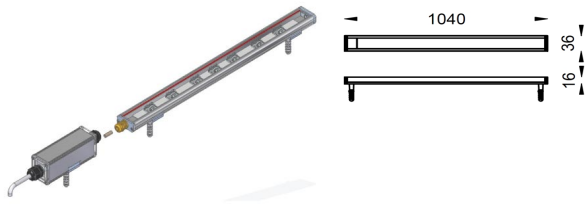

**26200000114** 1 **500**  
 15W 100lm/W 6000K

Led Color	Finish
C 6000K	W White
N 4000K	B Black
W 3000K	S Silver

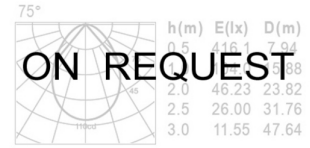

- Inground up light for LED for mounting into concrete surface.
- Inner casing is one piece ss-304/316 electro polished to give long life.

- Double silicone gasket design for moisture protection.
- Toughened step extra clear safety glass 12mm incorporated.

- Double powder coated with high U.V. resistance & corrosion resistance.
- High temperature rubber cable 3Cx0.5mm sq. H07RNF
- Extruded aluminium for better heatsink of LED



ULight

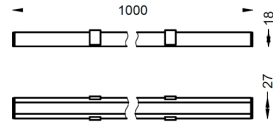
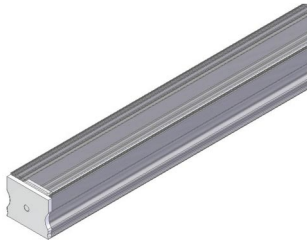

**3200000724 001 500**  
7W 355lm 6000K

<b>Led Color</b>	<b>Finish</b>
C 6000K	W White
N 4000K	B Black
W 3000K	S Silver

**3200001524 001 500**  
15W 1050lm 6000K

<b>Led Color</b>	<b>Finish</b>
C 6000K	W White
N 4000K	B Black
W 3000K	S Silver

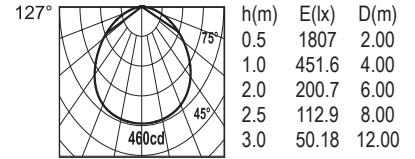

- Surface mounted low profile luminaire giving soft light at 45° angle to optimize light output from cabinets and coves and buttable for illuminating cabinets & shelves.
- Construction in extruded Anodized aluminum with buff finish

- Fixture holding system using double side tape
- Extruded aluminium for better heatsink of LED
- Strain relief cable clamp with quick connect LED harness
- LED constant to 2 macadam ellipse

- Reiz Electronic LED driver constant current remote, THD<10%, PF>0.95
- LED CRI : 85

ALight

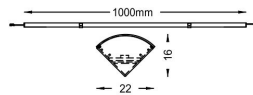
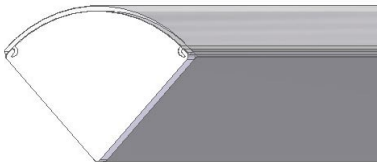

**3200000724 001 500**  
20W 100lm/W 6000K  
Length : 1000mm

<b>Led Color</b>	<b>Finish</b>
C 6000K	W White
N 4000K	B Black
W 3000K	S Silver

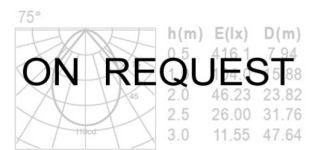

- Surface mounted low profile luminaire giving soft light at 45° angle to optimize light output from cabinets and coves
- Construction in extruded anodized aluminium with buff finish
- Fixture holding system using double side tape

- Dimmable for brightness control via 0 to 10V, 1 to 10V, potentiometer, phase cut
- Extruded aluminium for better heatsink of LED
- Strain relief cable clamp with quick connect LED harness
- Available with diffuser also

- Reiz Electronic LED driver constant current remote, THD<10%, PF>0.95
- LED consistent to 2 macadam ellipse
- LED CRI : 85

# Flexible Edgelit

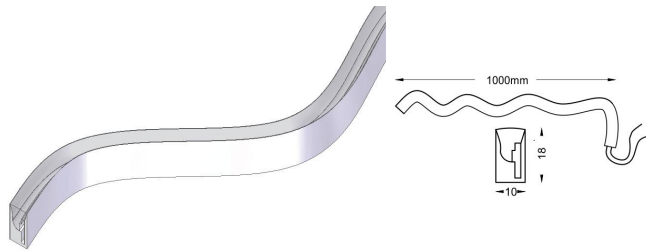

**2560000R232 001 300**  
 5W 100lm/W 6000K Length : 1000mm

<b>Led Color</b>	<b>Finish</b>
C 6000K	W White
N 4000K	B Black
W 3000K	S Silver

75°

**ON REQUEST**

h (m)	E (lx)	D (m)
0.5	416.1	7.94
1.0	104.0	15.88
2.0	26.0	31.76
3.0	11.55	47.64



- Surface mounted low profile luminaire giving soft diffuse light & buttable for illuminating cabinets & shelves
- Construction in extruded anodized aluminium with buff finish
- Fixture holding system using double side tape

- Dimmable for brightness control via 0 to 10V, 1 to 10V, potentiometer, phase cut
- Extruded aluminium for better heatsink of LED
- Strain relief cable clamp with quick connect LED harness
- Wire for mains supply cable 2C×1.5mm<sup>2</sup>

- Reiz Electronic LED driver constant current remote, THD<10%, PF>0.95
- L Channel can be ordered separately for tilting the outliner @ 45°
- LED CRI : 85



## Ledline T8

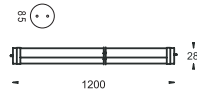
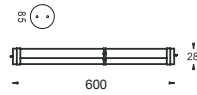

**1670000R248** 001 200  
9W 810lm 6000K Length : 600mm

Led Color	Finish
C 6000K	W White
N 4000K	B Black
W 3000K	S Silver

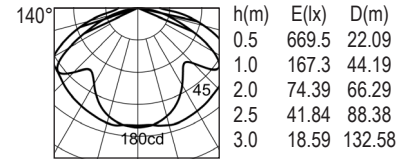

**1670000R296** 001 200  
18W 1720lm 6000K Length : 1200mm

Led Color	Finish
C 6000K	W White
N 4000K	B Black
W 3000K	S Silver

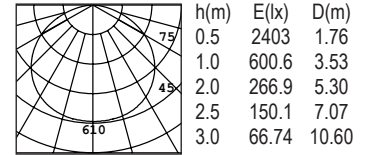

- Surface mounted low profile luminaire giving soft diffuse light & buttable for illuminating cabinets & shelves
- Construction in extruded anodized aluminium with buff finish
- Fixture holding system using double side tape

- Dimmable for brightness control via 0 to 10V, 1 to 10V, potentiometer, phase cut
- Extruded aluminium for better heatsink of LED
- Strain relief cable clamp with quick connect LED harness
- Wire for mains supply cable 2C×1.5mm<sup>2</sup>

- Reiz Electronic LED driver constant current remote, THD<10%, PF>0.95
- L Channel can be ordered separately for tilting the outliner @ 45°
- LED CRI : 85

## Ledline T5

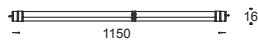
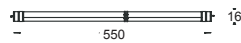

**1670000R248** 001 200  
9W 990lm 6000K Length : 550mm

Led Color	Finish
C 6000K	W White
N 4000K	B Black
W 3000K	S Silver

**1670000R296** 001 200  
18W 1980lm 6000K Length : 1150mm

Led Color	Finish
C 6000K	W White
N 4000K	B Black
W 3000K	S Silver

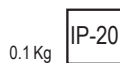

- Surface mounted low profile luminaire giving soft diffuse light & buttable for illuminating cabinets & shelves

- Construction in extruded anodized aluminium with buff finish
- Extruded aluminium for better heatsink of LED

- Reiz Electronic LED driver constant current remote, THD<10%, PF>0.95
- LED CRI > 80

Terra

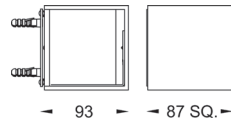
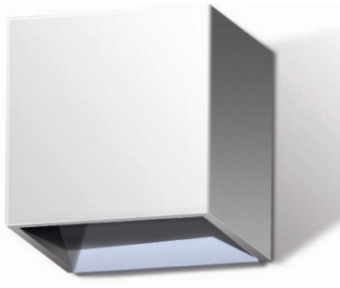

**18015300801** ■ 001 ■ 200  
 8W 650lm 6000K  
 Cut Off Angle : 80° Optics : 180°  
**Led Color** ■ **Finish**  
 C 6000K ■ W White  
 N 4000K ■ B Black  
 W 3000K ■ S Silver

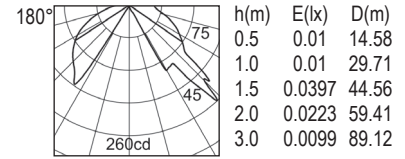

- Low glare indirect up down light for throwing grazing light for wall wash in corridors and living areas
- Construction in pressed metal sheet and extruded aluminium

- Powder coated for corrosion resistance
- Dimmable for brightness control via 0 to 10V, 1 to 10V, potentiometer, phase cut
- Extruded aluminium for better heatsink of LED
- Strain relief cable clamp with terminal block

- Wire for mains supply cable 3c×1.5mm<sup>2</sup>
- Reiz Electronic LED driver constant current integrated, THD<10%, PF>0.95
- LED CRI : 85

Wave

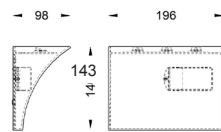

**21718301501** ■ 001 ■ 200  
 15W 1210lm 6000K  
 Optics : 90°  
**Led Color** ■ **Finish**  
 C 6000K ■ W White  
 N 4000K ■ B Black  
 W 3000K ■ S Silver

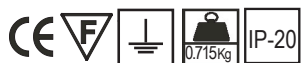
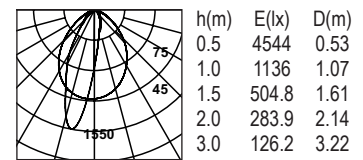

- Wall mounted uplighter for grazing of walls for use in hotels and restaurants
- Construction in die-cast aluminium and pressed metal sheet
- Powder coated for corrosion resistance

- Dimmable for brightness control via 0 to 10V, 1 to 10V, potentiometer, phase cut
- Extruded aluminium for better heatsink of LED
- Strain relief cable clamp with terminal block
- Wire for mains supply cable 3C×1.5mm<sup>2</sup>

- Reiz Electronic LED driver constant current integrated, THD<10%, PF>0.95
- LED CRI : 85



# SUSPENSION LUMINAIRES

Convenient and user friendly, these luminaires come with adjustable stainless steel suspension system to optimize height. They can be personalised using LED colors, optics and finish.

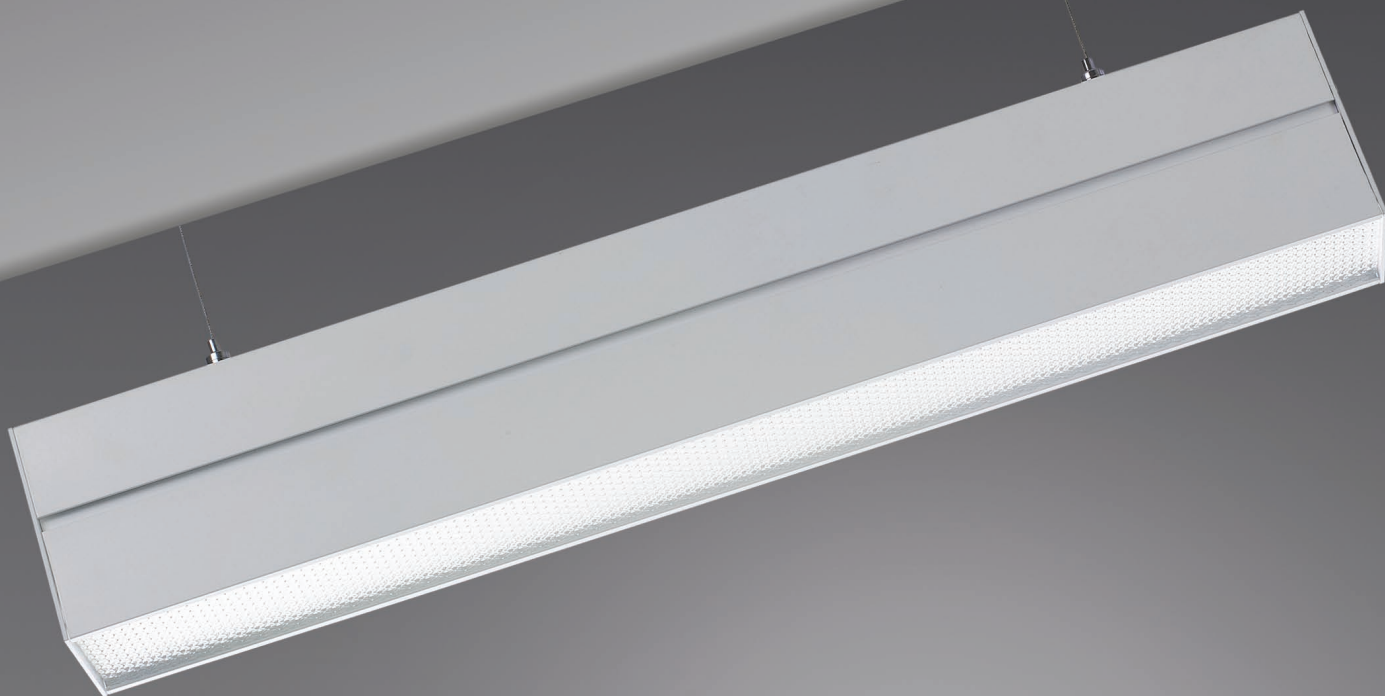

Rapier

## Kan Nano S

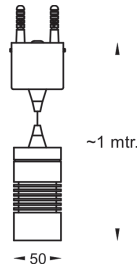

**02000800204** 1 200  
 8W 725lm 6000K  
 Cut Off Angle : 10°

Led Color	Optics	Finish
C 6000K	12°	W White
N 4000K	24°	B Black
W 3000K	36°	S Silver

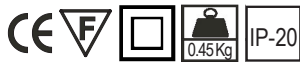
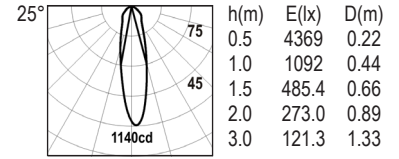

- Suspended round spot light ceiling mounted for accent lighting in residential and retail areas.
- Construction with extruded aluminium and machined brass.
- Incremental suspension SS-304 wire adjustable upto 1 meter

- Dimmable for brightness control via 0 to 10V, 1 to 10V, potentiometer, phase cut
- Extruded aluminium for better heat sink of LED
- Strain relief cable clamp with terminal block
- Powder coated with high U.V. & corrosion resistance

- Wire from mains up to 2 core × 0.75mm<sup>2</sup>.
- Reiz Electronic LED driver constant current integrated, THD<15%, PF>0.95
- LED CRI : 85

## Kan Milli S

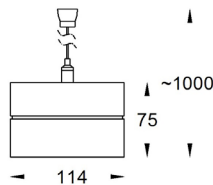

**02001300206** 001 200  
 15W 1435lm 6000K  
 Cut Off Angle : 40° Optics : 100°

Led Color	Finish
C 6000K	W White
N 4000K	B Black
W 3000K	S Silver

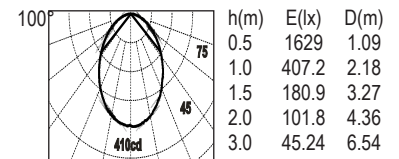

- Suspended round spot light ceiling mounted for accent lighting in residential and retail areas.
- Construction with extruded aluminium machined brass.
- High efficiency PMMA diffuser with 90% transmittance, U.V Stabilized

- Dimmable for brightness control via 0 to 10V, 1 to 10V, potentiometer, phase cut
- White Reflector with 98% Reflectance
- Incremental suspension SS-304 wire adjustable upto 1 meter
- Extruded aluminium for better heat sink of LED.

- Strain relief cable clamp with terminal block.
- Powder coated for corrosion resistance.
- Wire from mains up to 2 core × 1.5mm<sup>2</sup>.
- Reiz Electronic LED driver constant current integrated, THD<15%, PF>0.95
- LED CRI : 85



## Rapier

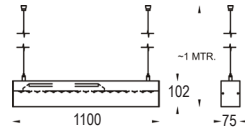

**14809500121** 1 2  
 20W 20184lm 6000K  
 Cut off Angle : 60°  
**Led Color** **Finish**  
 C 6000K W White  
 N 4000K B Black  
 W 3000K S Silver

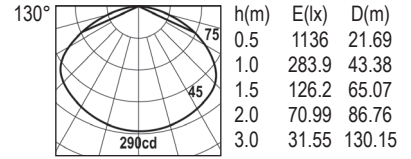

**1480950R572** 1 2  
 40W 3810lm 6000K  
 Cut Off Angle : 60° Optics : 131°  
**Led Color** **Finish**  
 C 6000K W White  
 N 4000K B Black  
 W 3000K S Silver

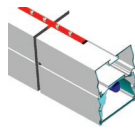
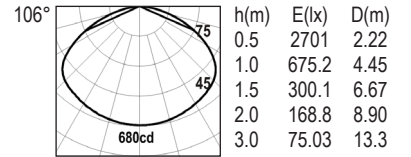

### M.S. Joiner Line

Rapiers can be joined end to end create a continuous streak of Light using the line joiner.

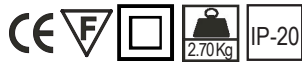

- LED luminaire for even diffused downward light
- Construction with extruded aluminium and machined brass
- Incremental suspension SS-304 wire adjustable upto 1mtr
- High efficiency PMMA diffuser with 90% transmittance, U.V Stabilized

- Dimmable for brightness control via 0 to 10V, 1 to 10V, potentiometer, phase cut
- Powder coated for corrosion resistance
- Fixture holding system using stainless steel-304 fastening springs
- Extruded aluminium for better heatsink of LED
- Strain relief cable clamp

- Wire for mains supply cable 3c×1.5mm<sup>2</sup>
- Line Joiner to be ordered separately
- Asymmetric option is only available in LED version
- Reiz Electronic LED driver constant current integrated, THD<10%, PF>0.95
- LED CRI : 85

## Rapier Mini

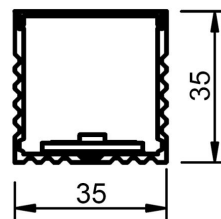
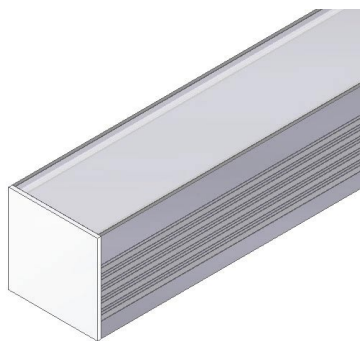

**1480950R572** 1 2  
 40W 2000lm up 2200lm down 6000K  
 Cut off Angle : 60°  
**Led Color** **Finish**  
 C 6000K W White  
 N 4000K B Black  
 W 3000K S Silver

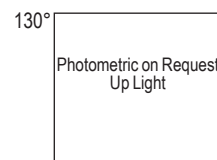

- Elementary Sleek fluorescent luminaire for mounting in general areas and coves.
- Construction in extruded Aluminum for good heat dissipation

- Polycarbonate channel with molded end caps.
- Reiz constant Voltage electronic driver 24V DC is remote
- High CRI LEDs >80

## Rapier Combo

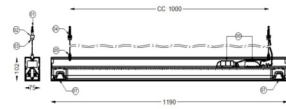
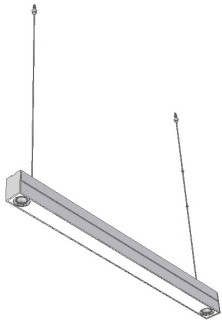

**1480950R572** 1 2 130°  
 40W 2000lm up 2200lm down 6000K  
 Cut off Angle : 60°

<b>Led Color</b>	<b>Finish</b>
C 6000K	W White
N 4000K	B Black
W 3000K	S Silver

Photometric on Request  
Up Light

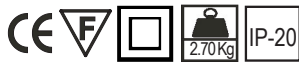

- LED luminaire for even diffused up & down light, The up LEDs lights up the ceiling to give a pleasant working atmosphere in offices
- Construction with extruded aluminium and machined brass
- Incremental suspension SS-304 wire adjustable upto 1mtr

- Dimmable for brightness control via 0 to 10V, 1 to 10V, potentiometer, phase cut
- High efficiency PMMA diffuser with 90% transmittance, U.V Stabilized
- Powder coated corrosion resistance
- Fixture holding system using stainless steel-304 fastening springs

- Extruded aluminium for better heatsink of LED
- Strain relief cable clamp
- Wire for mains supply cable 3c×1.5mm<sup>2</sup>
- Line Joiner to be ordered separately
- Reiz Electronic LED driver constant current integrated, THD<10%, PF>0.95
- LED CRI : 85

## Rapier Updown

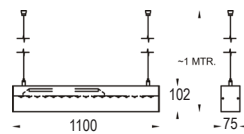

**1480950R572** 1 2 130°  
 40W 3815lm up 2200lm down 6000K  
 Cut off Angle : 60°

<b>Led Color</b>	<b>Finish</b>
C 6000K	W White
N 4000K	B Black
W 3000K	S Silver

Photometric on Request  
Up Light



- LED luminaire for even diffused up & down light, The up LEDs lights up the ceiling to give a pleasant working atmosphere in offices
- Construction with extruded aluminium and machined brass
- Incremental suspension SS-304 wire adjustable upto 1mtr

- Dimmable for brightness control via 0 to 10V, 1 to 10V, potentiometer, phase cut
- High efficiency PMMA diffuser with 90% transmittance, U.V Stabilized
- Powder coated corrosion resistance
- Fixture holding system using stainless steel-304 fastening springs

- Extruded aluminium for better heatsink of LED
- Strain relief cable clamp
- Wire for mains supply cable 3c×1.5mm<sup>2</sup>
- Line Joiner to be ordered separately
- Reiz Electronic LED driver constant current integrated, THD<10%, PF>0.95
- LED CRI : 85

# Rapier Combo Updown

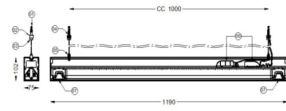
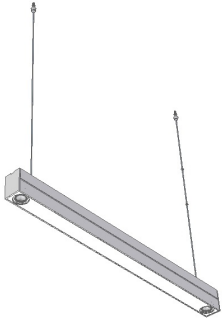

**1480950R572** ■ ■ ■ ■  
 50W 2515lm up 3000lm down 6000K  
 Cut off Angle : 60°

<b>Led Color</b>	<b>Finish</b>
C 6000K	W White
N 4000K	B Black
W 3000K	S Silver

Photometric on Request  
Up Light

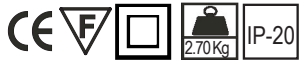

- LED luminaire for even diffused up & down light, The up LEDs lights up the ceiling to give a pleasant working atmosphere in offices
- Construction with extruded aluminium and machined brass
- Incremental suspension SS-304 wire adjustable upto 1mtr

- Dimmable for brightness control via 0 to 10V, 1 to 10V, potentiometer, phase cut
- High efficiency PMMA diffuser with 90% transmittance, U.V Stabilized
- Powder coated corrosion resistance
- Fixture holding system using stainless steel-304 fastening springs

- Extruded aluminium for better heatsink of LED
- Strain relief cable clamp
- Wire for mains supply cable 3c×1.5mm²
- Line Joiner to be ordered separately
- Reiz Electronic LED driver constant current integrated, THD<10%, PF>0.95
- LED CRI : 85



# Suspension Light Saber

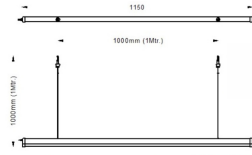
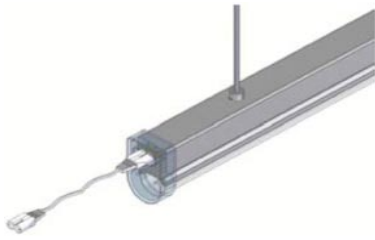

**01202002000 001 2B0**  
20W 110lm/W 6000K 25°

**Led Color**  
C 6000K  
N 4000K  
W 3000K

**Finish**  
W White  
B Black  
S Silver

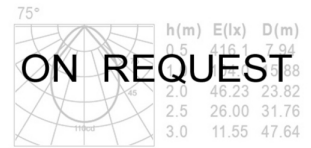

- LED luminaire for suspended even diffused up & downward light.
- Incremental suspension rod adjustable up to 50 mm.

- Elementary Sleek fluorescent luminaire for mounting in general areas.
- Construction in extruded Aluminum for good heat dissipation.
- Polycarbonate end caps with linkable connector.

- Reiz constant current electronic driver is integrated.
- High CRI LEDs >80

मॅकडोनाल्ड्स

मॅकडोनाल्ड्स



#ThodaTimeAur



Introducing  
MAHARAJA  
MAC





## Suspension Round Wand

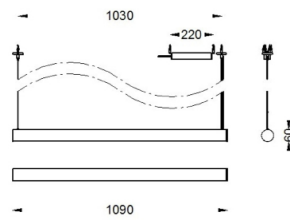

0000000000 000 0000  
20W 90lm/W 6000K

<b>Led Color</b>	<b>Finish</b>
C 6000K	W White
N 4000K	B Black
W 3000K	S Silver

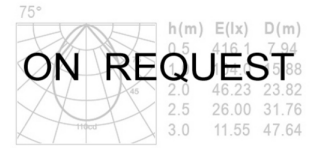

- LED luminaire for suspended even diffused downward light.
- The round wand made using aluminium Extrusion & extruded acrylic diffuser.
- Incremental suspension SS 304 wire adjustable upto 1 meter.

- Construction in Extrusion aluminium.
- Bracket mounts on a compass fitting mechanism internally.
- Powder coated with high U.V. & corrosion resistance.
- Extruded aluminium for better heat sink of LED

- Strain relief rubber EPDM grommet cable clamp.
- Wire for mains supply cable up to 2c×1.5mm<sup>2</sup>.
- Reiz energy saving LED driver is integrated, THD<10%, PF>0.95%.

## Suspension Sunray

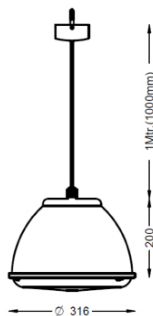

24800015W 0001 200  
15W 110lm/W 6000K

<b>Led Color</b>	<b>Finish</b>
C 6000K	W White
N 4000K	B Black
W 3000K	S Silver

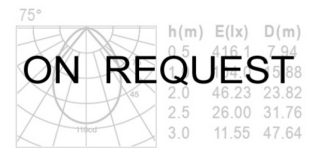

- LED luminaire for suspended even diffused downward light.
- Suspension cable 1Mtr.
- Ideal for reception, restaurant

- Construction in extruded Aluminium for good heat dissipation.
- Polycarbonate dome with striations.
- Reiz constant current electronic driver is integrated.

- Reiz Electronic LED driver constant current integrated, THD<10%, PF>0.95.
- High CRI LEDs >80

# TASK LUMINAIRES

These lights are designed to highlight specific area minimising light spill. Designed for easy and lasting adjustability they can be personalised using LED colors, optics and finish.



Scan Jet

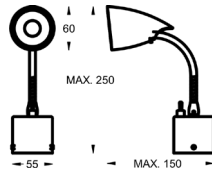

**11201200801** 1 200  
 8W 628lm 6000K  
 Cut Off Angle : 22°  
 Led Color Optics Finish  
 C 6000K 12° W White  
 N 4000K 24° B Black  
 W 3000K 36° S Silver

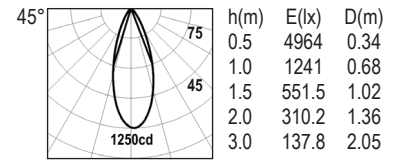

- Low Profile reading light with integrated switches for focused spot lighting for hotels, bedrooms and study rooms
- Construction in aluminium die-cast and pressed metal sheet with flexible brass goose pipes
- High efficiency optics grade PMMA Lens

- Dimmable for brightness control via 0 to 10V, 1 to 10V, potentiometer, phase cut
- Powder coated for corrosion resistance
- Lamp and fixture holding system using stainless steel-304 fastening springs
- Extruded aluminium for better heatsink of LED

- Strain relief cable clamp with terminal block
- Wire for mains supply cable 3C×1.5mm<sup>2</sup>
- Reiz Electronic LED driver constant current integrated, THD<10%, PF>0.95
- LED CRI : 85

Scan Cell

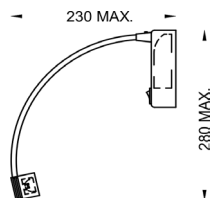

**16616200201** 1 200  
 3W 269lm 6000K  
 Cut Off Angle : 5°  
 Led Color Optics Finish  
 C 6000K 12° W White  
 N 4000K 24° B Black  
 W 3000K 36° S Silver

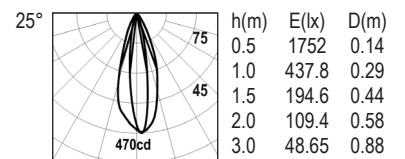

- Rectangular reading light with integrated switch for low glare focused spot lighting for hotels, bedrooms and study rooms
- Construction in aluminium die-cast and pressed metal sheet with flexible brass goose pipes
- Chrome plated with P.U. lacquer

- Dimmable for brightness control via 0 to 10V, 1 to 10V, potentiometer, phase cut
- High efficiency optics grade PMMA Lens
- Powder coated corrosion resistance
- Extruded aluminium for better heatsink of LED

- Strain relief cable clamp with terminal block
- Wire for mains supply cable 3c×1.5mm<sup>2</sup>
- Reiz Electronic LED driver constant current integrated, THD<10%, PF>0.95
- LED CRI : 85





Modern Bazaar, New Delhi





**BIOTIQUE**



**PRIMUS**